

PALAZZETTI

IL CALORE CHE PIACE ALLA NATURA

IT MANUALE USO E MANUTENZIONE

EN USER AND MAINTENANCE MANUAL

DE BEDIENUNGS UND WARTUNGSANLEITUNGEN

FR MANUEL D'UTILISATION ET D'ENTRETIEN

ES MANUAL DE USO Y MANTENIMIENTO

STUFE A PELLETT ECOFIRE® IDRO

ECOFIRE® IDRO PELLETT STOVES - IDRO PELLETTÖFEN ECOFIRE®
POELES A PELLETS ECOFIRE® IDRO - ESTUFAS DE PELLETS ECOFIRE® IDRO



EASY TOUCH

*Il presente manuale è parte integrante del prodotto.
Si raccomanda di leggere attentamente le istruzioni prima
dell'installazione, manutenzione o utilizzo del prodotto.*

*This manual is an integral part of the product.
Read the instructions carefully before installing, servicing or
operating the product.*

*Die vorliegende Anleitung ist fester Bestandteil des Produkts.
Vor der Installation, Wartung und Verwendung die Anleitungen
stets aufmerksam durchlesen.*

*Le présent manuel fait partie intégrante du produit.
Il est conseillé de lire attentivement les consignes
avant l'installation, l'entretien ou l'utilisation du produit.*

*Este manual es parte integrante del producto.
Se recomienda leer detenidamente las instrucciones antes
de la instalación, el mantenimiento y el uso del producto.*

IT

GENTILE CLIENTE,
DESIDERIAMO INNANZITUTTO RINGRAZIARLA PER LA PREFERENZA CHE HA VOLUTO ACCORDARCI ACQUISTANDO IL NOSTRO PRODOTTO E CI CONGRATULIAMO CON LEI PER LA SCELTA.
PER CONSENTIRLE DI UTILIZZARE AL MEGLIO LA SUA NUOVA STUFA, LA INVITIAMO A SEGUIRE ATTENTAMENTE QUANTO DESCRITTO NEL PRESENTE MANUALE.

GB

DEAR CUSTOMER,
WE'D LIKE TO THANK YOU FOR HAVING PURCHASED ONE OF OUR PRODUCTS AND CONGRATULATE YOU ON YOUR CHOICE.
TO MAKE SURE YOU GET THE MOST OUT OF YOUR NEW STOVE, PLEASE CAREFULLY FOLLOW THE INSTRUCTIONS PROVIDED IN THIS MANUAL.

DE

SEHR GEEHRTER KUNDE,
ZUALLERERST MÖCHTEN WIR IHNEN FÜR DEN UNS GEWÄHRTEN VORZUG DANKEN UND IHNEN ZUR WAHL GRATULIEREN.
DAMIT SIE IHREN NEUEN HEIZOFEN SO GUT WIE MÖGLICH BENUTZEN KÖNNEN, BITTEN WIR SIE, DIE IN DIESER **BEDIENUNGS- UND WARTUNGSANLEITUNG** ENTHALTENEN **ANGABEN** GENAU ZU BEFOLGEN.

F

CHER CLIENT,
NOUS SOUHAITONS AVANT TOUT VOUS REMERCIER DE LA PRÉFÉRENCE QUE VOUS NOUS AVEZ ACCORDÉE EN ACHETANT NOTRE PRODUIT ET VOUS FÉLICITONS POUR VOTRE CHOIX.
AFIN DE VOUS PERMETTRE DE PROFITER AU MIEUX DE VOTRE NOUVEAU POËLE, NOUS VOUS INVITONS À SUIVRE ATTENTIVEMENT LES INSTRUCTIONS REPORTÉES DANS CETTE NOTICE.

ES

ESTIMADO CLIENTE,
DESEAMOS AGRADECERLE POR LA PREFERENCIA QUE NOS HA OTORGADO ADQUIRIENDO NUESTRO PRODUCTO Y LO FELICITAMOS POR SU ELECCIÓN.
PARA EL MEJOR USO DE SU NUEVA ESTUFA, LO INVITAMOS A LEER CON ATENCIÓN CUANTO SE DESCRIBE EN EL PRESENTE MANUAL.

INDICE

1 PANNELLO COMANDI

- 1.1 DESCRIZIONE
- 1.2 USO DEL PANNELLO COMANDI
- 1.3 PARAMETRI DI FUNZIONAMENTO

2 OPERAZIONI PRELIMINARI

- 2.1 CARICAMENTO PELLET
- 2.2 ALIMENTAZIONE ELETTRICA
- 2.3 IMPOSTAZIONI INIZIALI

3 UTILIZZO DELLA STUFA

- 3.1 ACCENSIONE
- 3.2 MODIFICA DEI PARAMETRI
- 3.3 SPEGNIMENTO
- 3.4 FUNZIONAMENTO CON TERMOSTATO AMBIENTE
- 3.5 FUNZIONAMENTO CON SONDA AMBIENTE A BORDO CALDAIA
- 3.6 FUNZIONAMENTO IN ABBINAMENTO CON UN ACCUMULO
- 3.7 FUNZIONAMENTO IN ABBINAMENTO AL SISTEMA "EVERSPRING"

4 FUNZIONI DISPONIBILI

- 4.1 FUNZIONE TIMER
- 4.2 FUNZIONE RISPARMIO "ECO MODE"
- 4.3 RIACCENSIONE DOPO IL BLACK-OUT
- 4.4 FUNZIONE "BLOCCO TASTIERA"
- 4.5 FUNZIONE ANTIGELO
- 4.6 FUNZIONE DELTA DI RIACCENSIONE
- 4.7 ATTIVAZIONE MANUALE DEL SISTEMA DI CARICAMENTO

5 GESTIONE DEGLI ALLARMI

1 PANNELLO COMANDI

Prima di procedere con la lettura del manuale, prendere visione della descrizione della stufa contenuta nel relativo manuale allegato.

1.1 DESCRIZIONE

Il pannello comandi è composto da:

- A) una parte superiore con i led di stato e le icone retroilluminate che identificano ciascuna funzione;
- B) display a led;
- C) tasto di accensione;
- D) tasto "Annulla" e visualizzazione "errore";
- E) due tasti freccia per spostarsi tra le varie funzioni;
- F) due tasti **+** e **-** per accedere ai sottomenu e modificare i parametri di funzionamento;
- G) un tasto di invio **↵** per la conferma del parametro o della selezione.

 *Tutti i tasti sono di tipo capacitivo, pertanto non necessitano di una pressione per essere attivati, ma è sufficiente sfiorarne la superficie.*

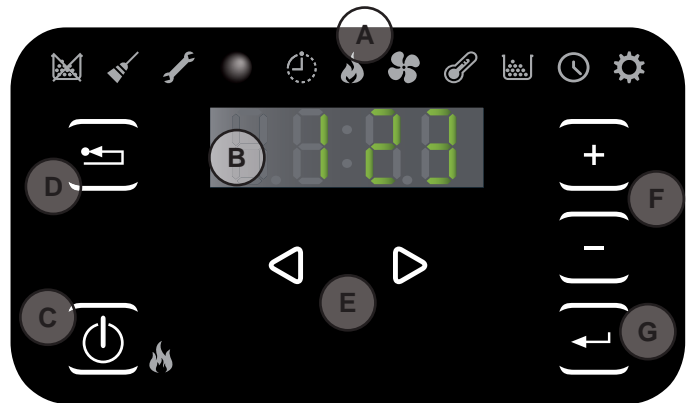















Fig. 1.1

1.1.1 Led di stato

ICONA	AVVISO	DESCRIZIONE
	Pellet in esaurimento	Indica che è necessario ricaricare il serbatoio di pellet.
	Manutenzione	Indica la necessità di effettuare una manutenzione
	Assistenza	Indica la presenza di un errore
	Ricevitore del telecomando	OPZIONALE
	Timer attivo	Indica se è attiva la funzione timer.
	Led di segnalazione stato (vicino al tasto )	Led sempre acceso: stufa accesa e in lavoro Led intermittente: stufa in fase di accensione o in stand-by Led spento: stufa spenta

1.1.2 Descrizione dei menu

ICONA	FUNZIONE	DESCRIZIONE	VALORI
	Potenza	Impostazione della potenza di funzionamento	1..5
	Ventilazione	Impostazione della velocità del ventilatore dell'aria quando la stufa è collegata in configurazione 5 al sistema Everspring	1..5; Auto; Hi
	Temperatura	Visualizza la temperatura letta dalla sonda* e permette di impostare la temperatura desiderata. *config.1: sonda di mandata; config.2 e 5: sonda ambiente; config. 3-4: sonda esterna/accumulo;	config.1: 65..80 °C config.2-5: 10.. 48 °C config.3-4: 45..75 °C
	Combustibile	Funzione non utilizzata	
	Timer	Abilita o disabilita il Timer. Quando è abilitato verrà visualizzata l'icona fissa 	ON - OFF

ICONA	FUNZIONE	SOTTOMENU	DESCRIZIONE	VALORI
	Setup	[1] Timer settimanale	Assegnazione dei programmi (max 3) ai vari giorni della settimana	[d1] ... [d7]
		[2] Programmi	Menu di impostazione dei programmi	[P1] ... [P6]
		[3] Orologio / data	Impostazione orologio e data	
		[4] Ore Residue	Visualizza le ore mancanti alla manutenzione consigliata. Con il valore "Hi" si indica un numero superiore alle 999 ore.	
		[5] Informazioni di sistema	Visualizza la versione software corrente	
		[6] Temperatura acqua	Consente di impostare la temperatura desiderata per l'acqua di mandata (solo in configurazione 2 - 5)	60 ... 80°C
		[7] Funzione Eco	Abilita o meno l'Eco Mode che comporta lo spegnimento e la riaccensione automatica in funzione della temperatura ambiente (solo in configurazione 2 - 5)	OFF; Eco
		[8] Delta di riaccensione	Differenza di gradi, rispetto alla temperatura di spegnimento al di sotto della quale la stufa si riaccende (escluso in configurazione 1).	0,5 ... 5,0°C 0 ... 40°C
		[9] Temperatura antigelo	Temperatura minima al di sotto della quale la stufa si accende (escluso in configurazione 1).	OFF; 3 ... 20 °C OFF; 3 ... 50 °C
		[10] Blocco tastiera	Imposta la modalità di blocco dei tasti	OFF; Lo; Hi
		[11] Luminosità display	Imposta il grado di luminosità del display	OFF; 1 ... 5
		[12] Modalità display	Imposta la modalità di visualizzazione dei dati	OFF; 1 ... 4
		[13] Volume cicalino	Imposta il volume dell'avviso acustico	OFF; 1 ... 5
		[14] Combustione	È possibile impostare 3 diverse configurazioni di combustione	1 ... 3
		[30] Menu Installatore	Modifica/Visualizza la configurazione della stufa	PWD: "54"
		[31] Carico coclea manuale	Attivazione manuale del sistema di carica del pellet	PWD: "54"
[33] Alimentazione pompa	Menu di competenza del centro di assistenza	PWD: "54"		
[34] Abilita / Disabilita modulazione pompa	Menu di competenza del centro di assistenza	PWD: "54"		
[40] Menu di servizio	Menu di competenza del centro di assistenza			

I sottomenu [30] e [40] del menu Setup sono protetti da password e sono ad uso esclusivo del centro di assistenza tecnico.

1.2 USO DEL PANNELLO COMANDI

- Agendo sui tasti freccia (◀) (▶) ci si sposta tra i diversi menu che si illuminano di volta in volta.
- Soffermandosi su una determinata funzione si possono scorrere gli eventuali sottomenu con i tasti (+) (-); per modificare un parametro basta agire sul tasto (←) e modificarne i valori, sempre con i tasti (+) (-). Una ulteriore pressione del tasto (←) conferma la modifica.
- In generale tutti i valori lampeggianti sono in quel momento modificabili con i tasti (+) (-).
- Il tasto "annulla" (↵) consente di tornare indietro di un livello nei menu; la sua pressione prolungata permette la visualizzazione sul display un eventuale codice di allarme o di errore.

1.3 PARAMETRI DI FUNZIONAMENTO

Il funzionamento della stufa è determinato dai parametri di Potenza e Temperatura impostati dall'utente.

1.3.1 Modifica della potenza

La potenza definisce la quantità di calore prodotta dalla stufa e quindi incide direttamente anche sui consumi. Per modificare la potenza portarsi con i tasti (◀) (▶) sul menu potenza 🔥

- a) Scorrere con i tasti (+) (-) il sottomenu
- b) Selezionare il sottomenu "1" e confermare con il tasto (←).
- c) Lampeggerà il valore di potenza; modificarne il valore con i tasti (+) (-) (1 minimo, ..., 5 massimo)
- d) Premere il tasto (←) per confermare i dati impostati.

1.3.2 Modifica della temperatura

In funzione della configurazione installativa della caldaia è possibile intervenire su diversi valori di temperatura:

- a) Portarsi con i tasti (◀) (▶) sul menu temperatura 🌡️ e premere il tasto (←);
- b) Lampeggerà il valore attuale; modificarlo con i tasti (+) (-);
- c) Premere il tasto (←) per confermare il dato impostato.

Temperatura acqua (solo nelle configurazioni installative 1): variando questo valore si varia la temperatura desiderata di mandata dell'acqua calda da parte della caldaia.

Temperatura ambiente (solo nelle configurazioni installative 2 e 5): modificando tale valore si definisce la temperatura che si desidera raggiungere in ambiente, letta direttamente da una sonda posta sulla caldaia.

Temperatura accumulo (solo nelle configurazioni installative 3 e 4): identifica la temperatura minima che si desidera mantenere all'interno dell'accumulo.

1.3.3 Modifica della ventilazione (solo se collegata, in configurazione 5, al sistema Everspring)

Per modificare il valore della ventilazione del sistema Everspring:

- a) Portarsi con i tasti (◀) (▶) sul menu ventilazione 🌀 e premere il tasto (←);
- b) Lampeggerà il valore di ventilazione; modificarne il valore con i tasti (+) (-):
 - "1" minimo, ..., "5" massimo;
 - "Auto" = funzionamento automatico (la stufa imposterà la velocità in funzione della temperatura ambiente);
 - "Hi" = funzionamento ultraveloce (da utilizzare solo se c'è la necessità di riscaldare velocemente un ambiente);
- c) Premere il tasto (←) per confermare i dati impostati.

2 OPERAZIONI PRELIMINARI

2.1 CARICAMENTO PELLET

La prima operazione da eseguire prima di accendere il prodotto è quella di riempire il serbatoio di combustibile (pellet).

Il pellet deve essere versato nel serbatoio con una paletta.

Non svuotare il sacco direttamente nel serbatoio per evitare di caricare della segatura o altri elementi estranei che potrebbero compromettere il buon funzionamento della stufa e per evitare di disperdere il pellet al di fuori del serbatoio stesso.



Assicurarsi di richiudere bene il coperchio del serbatoio dopo aver effettuato l'operazione di caricamento del pellet. Un interruttore di sicurezza (solo per i modelli dove previsto) ne verifica la corretta chiusura (IS in fig. 2.1)

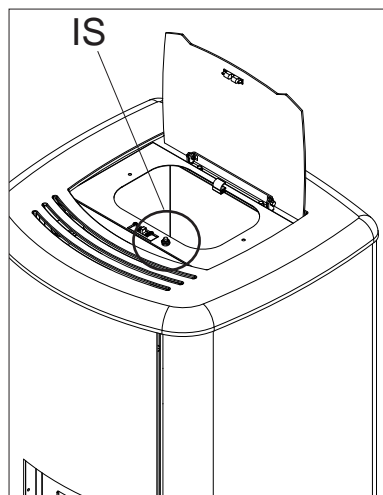

Fig. 2.1

2.2 ALIMENTAZIONE ELETTRICA

Collegare la stufa alla rete elettrica, agire sull'interruttore di accensione posto sul retro della stufa posizionandolo su "I" (Fig. 2.2). Se il collegamento è corretto la stufa emette una serie di segnali acustici intermittenti, si accende il display.



Per lunghi periodi di inutilizzo, si consiglia di posizionare l'interruttore sul retro della macchina in posizione di OFF (O).

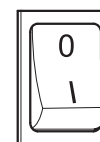

Fig. 2.2

2.3 IMPOSTAZIONI INIZIALI

Prima di utilizzare la stufa è necessario impostare la data e l'ora corrente.

2.3.1 Impostazione orario e data

Per modificare la data:

- Portarsi con i tasti ◀ ▶ sul menu setup ⚙ e premere il tasto ↵
- Selezionare la password "7" con il tasto + e confermare con il tasto ↵ ;
- Scorrere con il tasto + , selezionare il sottomenu [3] e confermare con il tasto ↵ ;
- Lampeggerà il valore dell'ora; modificarne il valore con i tasti + - e premere il tasto ▶;
- Lampeggerà il valore dei minuti; modificarne il valore con i tasti + - e premere il tasto ▶;
- Lampeggerà il valore del giorno; modificarne il valore con i tasti + - e premere il tasto ▶;
- Lampeggerà il valore del mese; modificarne il valore con i tasti + - e premere il tasto ▶;
- Lampeggerà il valore dell'anno; modificarne il valore con i tasti + - e premere il tasto ▶;
- Lampeggerà il valore del giorno attuale della settimana (Lunedì =1 ... Domenica =7); modificarne il valore con i tasti + -;
- Premere il tasto ↵ per confermare i dati impostati.

2.3.2 Impostazione modalità display

E' possibile impostare cosa si vorrà visualizzare sul display quando quest'ultimo è nella modalità standby

- a) Andando sui tasti freccia ◀ ▶ portarsi sul menu setup ⚙ e premere il tasto ↵;
- b) Selezionare la password "7" con il tasto + e confermare con il tasto ↵;
- c) Scorrere con il tasto + e selezionare il sottomenu [12] e confermare con il tasto ↵;
- d) Impostare con i tasti + e - uno dei seguenti valori:
 - "0FF" • Il display resterà fisso sull'ultima visualizzazione operata dall'utente;
 - "1" • Verranno visualizzati ciclicamente tutti i parametri di funzionamento;
 - "2" • Viene visualizzata la temperatura (della sonda ambiente o dell'acqua in funzione del tipo di configurazione)
 - "3" • Viene visualizzata l'ora corrente
 - "4" • Viene visualizzata l'autonomia in ore prima di dover ricaricare il serbatoio, se la funzione rifornimento è stata abilitata.
- e) Premere il tasto ↵ per confermare i dati impostati.

2.3.3 Impostazione luminosità display

E' possibile impostare il grado di attenuazione della luminosità del display quando è nella modalità standby.

- a) Andando sui tasti freccia ◀ ▶ portarsi sul menu setup ⚙ e premere il tasto ↵;
- b) Selezionare la password "7" con il tasto + e confermare con il tasto ↵;
- c) Scorrere con il tasto + e selezionare il sottomenu [11] e confermare con il tasto ↵;
- d) Impostare con i tasti + e - il valore di luminosità desiderato (OFF, 1 ... 5) e confermare con il tasto ↵.

2.3.4 Impostazione volume

E' possibile impostare il livello di volume del cicalino, in base alle proprie necessità:

- a) Andando sui tasti freccia ◀ ▶ portarsi sul menu setup ⚙ e premere il tasto ↵;
- b) Selezionare la password "7" con il tasto + e confermare con il tasto ↵;
- c) Scorrere con il tasto + e selezionare il sottomenu [13] e confermare con il tasto ↵;
- d) Impostare con i tasti + e - il livello di volume desiderato (OFF, 1 ... 5) e confermare con il tasto ↵.

2.3.5 Ottimizzazione della combustione

Una combustione ottimale dipende da diversi fattori (tipo di installazione, condizioni di funzionamento e di manutenzione, tipologia di pellet ecc..)

In linea di massima, se a fine combustione, nel braciere restano molti residui, è consigliabile modificare le configurazioni di combustione (aumentandone il valore) fino a trovare la soluzione più soddisfacente.

- a) Andando sui tasti freccia ◀ ▶ portarsi sul menu setup ⚙ e premere il tasto ↵;
- b) Selezionare la password "7" con il tasto + e confermare con il tasto ↵;
- c) Scorrere con il tasto + e selezionare il sottomenu [14] e confermare con il tasto ↵;
- d) Impostare con i tasti + e - uno dei seguenti valori:
 - "1"
 - "2"
 - "3"
- e) Premere il tasto ↵ per confermare i dati impostati.

3 UTILIZZO DELLA STUFA

3.1 ACCENSIONE

 Prima di ogni accensione, accertarsi che il braciere sia completamente vuoto e correttamente posizionato nella sua sede.

Per accendere la stufa tenere premuto il tasto  per qualche secondo.

L'icona a forma di fiamma inizierà a lampeggiare, durante la fase di accensione fino a restare fissa a stufa accesa.

 Accensione automatica: la stufa è dotata di un dispositivo automatico che consente l'accensione del pellet senza l'utilizzo di altri accenditori tradizionali.

 Evitare di accendere manualmente la stufa se il sistema di accensione automatico è compromesso.

 Durante la prima accensione della stufa si possono generare sgradevoli odori o fumi causati dall'evaporazione o dall'essiccamento di alcuni materiali utilizzati. Tale fenomeno andrà via via a scomparire.

Si consiglia, durante le prime accensioni, di mantenere i locali ben arieggiati.

3.2 MODIFICA DEI PARAMETRI

E' possibile modificare i parametri di funzionamento della stufa secondo quanto già riportato.

 I valori impostati verranno mantenuti fino alla successiva variazione, anche a stufa spenta o scollegata dall'alimentazione elettrica.

3.3 SPEGNIMENTO

Per spegnere la stufa tenere premuto il tasto  per qualche secondo; l'icona a forma di fiamma si spegnerà.

 Per effettuare una nuova accensione si consiglia di attendere che la stufa si sia completamente raffreddata.

 Si raccomanda di spegnere la stufa seguendo scrupolosamente quanto sopra riportato ed evitare assolutamente di farlo togliendo l'alimentazione elettrica.



3.4 FUNZIONAMENTO CON TERMOSTATO AMBIENTE

Quando la stufa viene comandata da un termostato (o cronotermostato) esterno, l'installatore deve avere impostato la configurazione 1.

In questa configurazione **la stufa si spegne** quando il termostato esterno è soddisfatto (circuito aperto) oppure modula il proprio funzionamento (cioè la stufa tenta di mantenere la temperatura

desiderata consumando il meno possibile) al raggiungimento della temperatura dell'acqua, impostata.

La stufa si riaccende automaticamente quando la temperatura scende al di sotto del valore impostato sul termostato esterno (circuito chiuso).

 **Alla prima accensione, o qualora lo spegnimento sia avvenuto direttamente dalla stufa (tasto ), si dovrà procedere ad accendere la stufa direttamente dal pannello comandi.**



La stufa si spegnerà anche nell'eventualità in cui la temperatura dell'acqua continui a crescere nonostante la modulazione. In questo caso la stufa si riaccenderà solo se la differenza di temperatura tra il valore impostato e quello reale è maggiore di 20°C.

È consigliabile pertanto, in questa configurazione, impostare la temperatura dell'acqua su un valore alto (es. 70°C).

3.5 FUNZIONAMENTO CON SONDA AMBIENTE A BORDO CALDAIA

La caldaia può essere accesa/spenta manualmente o in modo programmato.

In questo tipo di configurazione, la caldaia modula la potenza in funzione della temperatura ambiente letta dalla sonda a bordo (cioè la caldaia tenta di mantenere la temperatura desiderata consumando il meno possibile).

Nell'eventualità l'utente abbia abilitato la funzione "Eco-mode" nel sottomenu [7] del menu setup , la caldaia invece di modulare, si spegne al raggiungimento della temperatura impostata, e si riaccende quando la temperatura ambiente scende al di sotto del delta indicato nel sottomenu [7] del menu setup .

È possibile impostare la temperatura desiderata in ambiente nel menu temperatura .

Nel sottomenu [6] del menu setup  si può impostare la temperatura desiderata dell'acqua di mandata (farsi suggerire dal proprio installatore termoidraulico, la temperatura più confacente al proprio impianto di riscaldamento).

3.6 FUNZIONAMENTO IN ABBINAMENTO CON UN ACCUMULO

Per il funzionamento in abbinamento ad un accumulo l'installatore avrà impostato la configurazione di funzionamento 3 o 4 a seconda se si tratta di accumulo con o senza serpentino interno.

La caldaia viene comandata dalla temperatura letta dalla sonda nell'accumulo.

Al raggiungimento della temperatura dell'accumulo impostata nel menu temperatura  la caldaia si spegne e si riaccende se la temperatura scende al di sotto del delta indicato nel sottomenu [8] del menu setup .

In questa configurazione è possibile impostare anche la funzione antigelo.

3.7 FUNZIONAMENTO IN ABBINAMENTO AL SISTEMA "EVERSPRING"



Prima di utilizzare il prodotto in abbinamento al sistema "Everspring" assicurarsi di aver letto tutta la documentazione fornita con l'impianto e di aver ricevuto adeguate istruzioni dall'installatore sul funzionamento dell'impianto stesso e dell'eventuale unità di raffrescamento.

Quando la stufa viene collegata al sistema Everspring, deve essere impostata nella configurazione 5.







In tale configurazione può essere accesa/spenta manualmente o in modo programmato.

La stufa può funzionare in modalità invernale (di default) oppure in modalità estiva, se il sistema Everspring prevede anche una unità di raffrescamento.

Attraverso il menu della ventilazione , l'utente può modificare la velocità dell'aria calda/fredda attraverso l'unità Everspring.

3.7.1 Funzionamento Invernale

Per passare dal funzionamento estivo a quello invernale, a stufa spenta (fredda) ma alimentata:

- Portarsi con i tasti   sul menu potenza  e premere il tasto  ;
- Lampeggerà il valore "SUN"; modificarlo con il tasto  fino a portarsi su un valore tra 1 e 5;
- Premere il tasto  per confermare la scelta.

In questo tipo di configurazione, la caldaia modula la potenza in funzione della temperatura ambiente letta dalla sonda a bordo del sistema Everspring (cioè la caldaia tenta di mantenere la temperatura desiderata consumando il meno possibile).







Nell'eventualità l'utente abbia abilitato la funzione "Eco-mode" nel sottomenu [7] del menu setup , la caldaia invece di modulare, si spegne al raggiungimento della temperatura impostata, e si riaccende quando la temperatura ambiente scende al di sotto del delta indicato nel sottomenu [8] del menu setup .

È possibile impostare la temperatura desiderata in ambiente nel menu temperatura .

Nel sottomenu [6] del menu setup  si può impostare la temperatura desiderata dell'acqua di mandata (è consigliabile impostare tale temperatura intorno ai 70°C).



3.7.2 Funzionamento Estivo (da utilizzare se esiste una unità di raffrescamento abbinata ad Everspring)

Per passare al funzionamento estivo è sufficiente, a stufa spenta (fredda) ma alimentata:

- Portarsi con i tasti   sul menu potenza  e premere il tasto  ;
- Lampeggerà il valore attuale; modificarlo con il tasto  fino a portarsi sul valore "SUN";
- Premere il tasto  per confermare la scelta.



Impostare la temperatura estiva desiderata in ambiente nel menu temperatura .

In questa modalità, la stufa attiva l'unità di raffrescamento quando la temperatura ambiente supera la temperatura impostata nel menu temperatura  e spegne l'unità quando la temperatura ambiente scende al di sotto del delta indicato nel sottomenu [8] del menu setup .

4 FUNZIONI DISPONIBILI

4.1 FUNZIONE TIMER

E' possibile impostare, abilitare ed assegnare ai vari giorni della settimana, i programmi personalizzati per l'accensione e/o lo spegnimento automatico della stufa.

























E' possibile configurare fino a sei programmi personalizzati.

Per ciascun programma si può impostare: ora di accensione, ora di spegnimento e temperatura desiderata.

A ciascun giorno della settimana è possibile assegnare fino a tre programmi.



















I giorni della settimana sono identificati da numeri: Lunedì = "d1", Martedì = "d2";...; Domenica = "d7".

4.1.1 Impostazione programmi







- Agendo sui tasti freccia   portarsi sul menu setup  e premere il tasto .
- Selezionare la password "7" con il tasto  e confermare con il tasto .
- Selezionare il sottomenu [2] e confermare con il tasto .
- Scorrere con i tasti  e  i programmi P1...P6; selezionare con il tasto  quello che si vuole modificare;
- Lampeggerà il valore dell'ora di accensione; modificarne il valore con i tasti  e  e premere il tasto .
- Lampeggerà il valore dei minuti; modificarne il valore con i tasti  e  e premere il tasto .
- Lampeggerà il valore dell'ora di spegnimento; modificarne il valore con i tasti  e  e premere il tasto .
- Lampeggerà il valore dei minuti; modificarne il valore con i tasti  e  e premere il tasto .
- Lampeggerà il valore della temperatura desiderata; modificarne il valore con i tasti  e .
- Premere il tasto  per confermare i dati impostati.

4.1.2 Assegnare i programmi ai giorni

Con questa funzione è possibile assegnare fino a tre programmi diversi ad un determinato giorno.

- Agendo sui tasti freccia   portarsi sul menu setup  e premere il tasto .
- Selezionare la password "7" con il tasto  e confermare con il tasto .
- Selezionare il sottomenu [1] e confermare con il tasto .
- Scegliere con i tasti  e  il giorno [d1]...[d7] al quale si vogliono associare i programmi;
- Selezionarlo con il tasto .
- Lampeggerà il valore del primo programma da assegnare: P1...P6 oppure "OFF" per disabilitarlo;
- Modificarne il valore con i tasti  e  e premere il tasto .
- Lampeggerà il valore del secondo programma da assegnare: P1...P6 oppure "OFF" per disabilitarlo;
- Modificarne il valore con i tasti  e  e premere il tasto .
- Lampeggerà il valore del terzo programma da assegnare: P1...P6 oppure "OFF" per disabilitarlo;
- Modificarne il valore con i tasti  e  e premere il tasto  per confermare i dati impostati.

4.1.3 Abilitazione/disabilitazione timer

- Agendo sui tasti freccia   portarsi sul menu Timer .
- Confermare con il tasto .
- Scorrere con i tasti  e  e selezionare: "ON" per abilitare il timer oppure "OFF" per disabilitarlo.
- Premere il tasto  per confermare la selezione.











Quando il timer è abilitato apparirà l'icona fissa  ad indicare che il timer è attivo.

4.2 FUNZIONE RISPARMIO “ECO MODE”

Abilitando questa funzione si fa in modo che la stufa, al raggiungimento della temperatura desiderata in ambiente, si spenga. Se tale funzione non è abilitata, la stufa modula il proprio funzionamento per mantenere la temperatura desiderata consumando il meno possibile.

La funzione “Eco Mode” è disponibile solo nella configurazione 2.

Per abilitare/disabilitare tale funzione:

- Agendo sui tasti freccia   portarsi sul menu setup  e premere il tasto .
- Selezionare la password “7” con il tasto  e confermare con il tasto .
- Selezionare il sottomenu [7] e confermare con il tasto .
- Impostare con i tasti  e  uno dei seguenti valori:
Eco → Abilita la funzione “Eco Mode”
Off → Disabilita la funzione “Eco Mode”
- Premere il tasto  per confermare i dati impostati.











4.3 RIACCENSIONE DOPO IL BLACK-OUT

In caso di interruzione di corrente elettrica, la stufa si riaccenderà automaticamente, verificando le condizioni di sicurezza, al ritorno dell'alimentazione.

4.4 FUNZIONE “BLOCCO TASTIERA”

Con questa funzione è possibile bloccare l'utilizzo del pannello comandi per evitare modifiche accidentali.

Per abilitare/disabilitare tale funzione:











- Agendo sui tasti freccia   portarsi sul menu setup  e premere il tasto .
- Selezionare la password “7” con il tasto  e confermare con il tasto .
- Selezionare il sottomenu [10] e confermare con il tasto .
- Impostare con i tasti  e  uno dei seguenti valori:
“Off” → Blocco tastiera disattivato
“Lo” → Resta abilitato solo il tasto di accensione/spegnimento 
“Hi” → Blocco tastiera attivato
- Premere il tasto  per confermare i dati impostati.

4.5 FUNZIONE ANTIGELO

Nelle configurazioni installative 2, 3 e 4 è possibile impostare una temperatura minima al di sotto della quale la caldaia si accende (al di fuori delle fasce orarie impostate).











Configurazione 2:

Per modificare il valore della temperatura di “antigelo”:

- Agendo sui tasti freccia   portarsi sul menu setup  e premere il tasto .
- Selezionare la password “7” con il tasto  e confermare con il tasto .
- Selezionare il sottomenu [9] e confermare con il tasto .
- Lampeggerà il valore; modificarlo con i tasti  e  (OFF; 3...20°C);
- Premere il tasto  per confermare il dato impostato.

Configurazione 3 e 4:

Per modificare il valore della temperatura di “antigelo”:

- Agendo sui tasti freccia   portarsi sul menu setup  e premere il tasto .
- Selezionare la password “7” con il tasto  e confermare con il tasto .
- Selezionare il sottomenu [9] e confermare con il tasto .
- Lampeggerà il valore; modificarlo con i tasti  e  (OFF; 3...50°C);
- Premere il tasto  per confermare il dato impostato.

Se al punto d. si imposta il valore “OFF”, tale funzione viene disabilitata.

4.6 FUNZIONE DELTA DI RIACCENSIONE

Delta di riaccensione: (nelle configurazioni installative 2, 3, 4 e 5) è il numero di gradi al di sotto della temperatura di spegnimento oltre il quale la stufa si riaccende automaticamente. Ad esempio se la stufa è impostata per spegnersi a 20°C (Eco Mode attivo) e impostiamo un "Delta di riaccensione" di 4°C, la stufa si riaccenderà quando rileva una temperatura inferiore o uguale a 16°C.

Configurazione 2 - 5:

Per modificare il valore del delta di riaccensione:

- Agendo sui tasti freccia ◀ ▶ portarsi sul menu setup ⚙ e premere il tasto ↵;
- Selezionare la password "7" con il tasto + e confermare con il tasto ↵;
- Selezionare il sottomenu [8] e confermare con il tasto ↵;
- Lampeggerà il valore; modificarlo con i tasti + e - (0,5 ... 5,0°C);
- Premere il tasto ↵ per confermare il dato impostato.

Configurazione 3 e 4:

Per modificare il valore del delta di riaccensione:

- Agendo sui tasti freccia ◀ ▶ portarsi sul menu setup ⚙ e premere il tasto ↵;
- Selezionare la password "7" con il tasto + e confermare con il tasto ↵;
- Selezionare il sottomenu [8] e confermare con il tasto ↵;
- Lampeggerà il valore; modificarlo con i tasti + e - (0 ... 40°C);
- Premere il tasto ↵ per confermare il dato impostato.

4.7 ATTIVAZIONE MANUALE DEL SISTEMA DI CARICAMENTO

In caso di primo utilizzo (serbatoio pellet inizialmente vuoto), o per testare il funzionamento del gruppo di carica, è possibile azionare manualmente la carica.

Sul pannello comandi della stufa:



- Agendo sui tasti freccia ◀ ▶ portarsi sul menu setup ⚙ e premere il tasto ↵;
- Selezionare la password "7" con il tasto + e confermare con il tasto ↵;
- Scorrere con il tasto + e selezionare il sottomenu [31] ;
- Selezionare la password "54" con il tasto + e confermare con il tasto ↵;
- Tenendo premuto il tasto ↵ il sistema di carica si attiverà e sul display verranno visualizzate delle barre incrementali.
- Rilasciando il tasto si porrà fine all'operazione di carica.

Attenzione!

- Questa funzione è attiva solo a stufa spenta e fredda.
- Prima di una nuova accensione assicurarsi che nel braciere non ci sia pellet.

5 GESTIONE DEGLI ALLARMI

Nel caso si verifichi un'anomalia nel funzionamento, viene attivata la seguente procedura:

1. allarme acustico (beep);
2. si illumina uno dei seguenti led di sistema:   ;
3. se l'anomalia riguarda un errore, la stufa si spegnerà.

La pressione prolungata del tasto "annulla"  consente la visualizzazione sul display del codice di errore:

CODICE ERRORE/AVVISO	DESCRIZIONE	POSSIBILI CAUSE	LED
E001	Pannello comandi difettoso	Difettosità del pannello comandi	
E002	Errore di comunicazione con il telecomando	Difettosità del pannello comandi	
E004	Errore di comunicazione	Cavo di collegamento tra scheda e pannello comandi interrotto o staccato. Se appare durante il cambio di configurazione, ignorare tale errore	
E101	Errore di mancata accensione Acqua di mandata eccessivamente calda	Mancanza di pellet Qualità del pellet Sistema di accensione guasto Braciere sporco Problemi sull'impianto di riscaldamento Problemi sul circolatore	
E105	Malfunzionamento sonda di temperatura	Sonda acqua di ritorno difettosa	
E106	Malfunzionamento sonda di temperatura	Sonda puffer difettosa	
E108*	Errore di sicurezza	Portina o sportello di caricamento aperti	
E108**	Errore di sicurezza termica	Problemi sull'impianto di riscaldamento Problemi sul circolatore Problemi di surriscaldamento del serbatoio pellet	
E109*	Errore di pressione o sicurezza termica	Sistema di evacuazione fumi sporco Guarnizioni di tenuta logorate Aria comburente insufficiente Problemi sull'impianto di riscaldamento Problemi sul circolatore Problemi di surriscaldamento del serbatoio pellet	
E109**	Errore di pressione	Sistema di evacuazione fumi sporco Guarnizioni di tenuta logorate Aria comburente insufficiente	
E110	Malfunzionamento sonda di temperatura	Sonda acqua di mandata difettosa Sonda aria difettosa	
E111	Malfunzionamento sonda fumi	Sonda temperatura fumi difettosa	
A001	Livello pellet basso (<i>icona lampeggiante</i>)	Pellet in esaurimento	
A002	Avviso di manutenzione programmata (<i>icone lampeggianti</i>)	Periodicamente la stufa richiede che venga effettuata una manutenzione da parte di un tecnico specializzato	
A007	Malfunzionamento sensore di pressione. (<i>icona lampeggiante</i>)	Sensore di pressione o scheda guasti.	
----	Pulizia stufa	Camera di combustione, braciere o sistema di evacuazione dei fumi sporchi. Tubi rilevamento pressione staccati o ostruiti. Ingresso dell'aria comburente ostruito.	
----	Errore di mancata accensione	Pellet esaurito; Resistenza di accensione guasta; Guarnizioni consumate; Posizione del braciere non corretta	

* Solo nelle stufe dotate di microinterruttori di sicurezza sulla portina e sul coperchio del serbatoio pellet.

** Solo nelle stufe sprovviste di microinterruttori di sicurezza sulla portina e sul coperchio del serbatoio pellet.

Dopo aver verificato il tipo messaggio è possibile resettare l'allarme premendo per qualche istante il tasto di accensione/spegnimento .

In caso d'errore "E109 o E108", riattivare il termostato a riarmo manuale posto sul retro della stufa (Fig. 11.1) prima di resettare l'allarme.

A questo punto è possibile procedere con una nuova accensione.



Fig.5.1

INDEX

1 CONTROL PANEL

- 1.1 DESCRIPTION
- 1.2 USING THE CONTROL PANEL
- 1.3 OPERATING PARAMETERS

2 PRELIMINARY OPERATIONS

- 2.1 LOADING THE PELLETS
- 2.2 POWER SUPPLY
- 2.3 INITIAL SETTINGS

3 STOVE OPERATION

- 3.1 STARTING THE STOVE
- 3.2 MODIFYING THE PARAMETERS
- 3.3 SWITCHING OFF
- 3.4 OPERATION WITH ROOM THERMOSTAT
- 3.5 OPERATION WITH ROOM PROBE ON THE BOILER
- 3.6 OPERATION IN COMBINATION WITH A STORAGE TANK
- 3.7 OPERATION IN CONJUNCTION WITH THE "EVERSPRING" SYSTEM

4 FUNCTIONS AVAILABLE

- 4.1 TIMER FUNCTION
- 4.2 "ECO MODE" SAVING FUNCTION
- 4.3 RESTARTING AFTER A POWER FAILURE
- 4.4 "LOCK KEYPAD" FUNCTION
- 4.5 FROST PROTECTION FUNCTION
- 4.6 RESTART DELTA FUNCTION
- 4.7 MANUAL ACTIVATION OF THE LOAD SYSTEM

5 ALARM MANAGEMENT

1 CONTROL PANEL

Before reading the manual, review the description of the stove given in the enclosed manual.

1.1 DESCRIPTION

The control panel consists of:

A) a top part with status LEDs and backlit icons that identify each function;

B) LED display;

C) ON button;

D) "Cancel" and display "error" button;

E) two arrow buttons to scroll between the various functions;

F) two buttons (+) and (-) to access the submenus and set the operating parameters;

G) an enter button (↵) to confirm the parameter or the settings;

 All the buttons are capacitive, therefore the functions are activated without needing to press hard on the buttons, rather by just touching the surface.

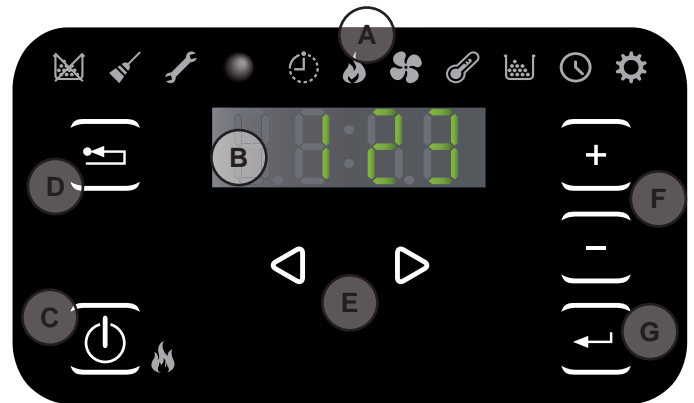















Fig. 1.1

1.1.1 STATUS LEDS

ICON	WARNING	DESCRIPTION
	Pellets running out	Indicates that the pellet hopper needs to be refilled.
	Maintenance	Indicates the need to perform maintenance
	Service	Indicates an error
	Remote control receiver	OPTIONAL
	Timer active	Indicates whether the timer function is active.
	Status LED (near the ) button)	LED on steady: stove on and operating LED flashing: stove in the ignition stage or in standby LED off: stove off

1.1.2 Description of the menus

ICON	FUNCTION	DESCRIPTION	VALUES
	Power	Stove output setting	1..5
	Fan	Setting of the air fan speed when the stove is connected in configuration 5 to the Everspring system.	1..5; Auto; Hi
	Temperature	Displays the probe* temperature reading and is used to set the desired temperature. *config.1: water probe; config.2-5: room probe; config. 3-4: external/tank probe.	config.1: 65..80 °C config.2-5: 10.. 48 °C config.3-4: 45..75 °C
	Fuel	Not used	
	Timer	Enables or disables the timer. When enabled, the icon  will be displayed steady (not flashing)	ON - OFF

ICON	FUNCTION	SUBMENU	DESCRIPTION	VALUES
	Setup	[1] Weekly timer	Assigns the programs (max 3) to the different days of the week	[d1] ... [d7]
		[2] Programs	Program setting menu	[P1] ... [P6]
		[3] Time / date	Time and date setting	
		[4] Hours remaining	Displays the number of hours remaining until recommended maintenance. When "Hi" is displayed, the remaining time exceeds 999 hours.	
		[5] System information	Displays the current software version	
		[6] Water temperature	It allows to set the desired temperature for the water supply (only in configuration 2-5).	60 ... 80°C
		[7] Eco function	Enables or disables Eco Mode, in which the stove automatically switches off and on based on room temperature (only in configuration 2-5).	OFF; Eco
		[8] Restart delta	Is the number of degrees centigrade below the switch-off temperature at which the stove switches on again automatically (except in configuration 1).	0,5 ... 5,0°C 0 ... 40°C
		[9] Frost protection temperature	Minimum temperature below which the stove switches on (except in configuration 1).	OFF; 3 ... 20 °C OFF; 3 ... 50 °C
		[10] Lock keypad	Disables the buttons on the keypad	OFF; Lo; Hi
		[11] Display brightness	Sets display brightness	OFF; 1 ... 5
		[12] Display mode	Sets how the data is displayed	OFF; 1 ... 4
		[13] Buzzer volume	Sets the buzzer volume	OFF; 1 ... 5
		[14] Combustion	Three different types of combustion can be set	1 ... 3
		[30] Installer menu	Sets/displays the stove configuration	PWD: "54"
		[31] Manual auger load	Manual activation of the pellet load system	PWD: "54"
[33] Pump power	Menu relating to the service centre	PWD: "54"		
[34] Enable/Disable	Menu di competenza del centro di assistenza	PWD: "54"		
[40] pump modulation	Menu relating to the service centre			

Submenus [30] and [40] in the Setup menu are password-protected and reserved for service centre personnel.

1.2 USING THE CONTROL PANEL

- The arrow buttons (◀ ▶) are used to scroll between the different menus that are highlighted.
- When selecting a given function, any submenus available can be scrolled using the (+ -) buttons; to set a parameter simply use the (↔) button and modify the values, again using the (+ -) buttons. Pressing the (↔) button confirms the setting.
- In general all values that are flashing can be modified using the (+ -) buttons.
- The “annulla” button (⏪) goes back up one level in the menu; pressing and holding the button displays any active alarm or error codes.

1.3 OPERATING PARAMETERS

Stove operation is determined by the Power level and Temperature parameters set by the user.

1.3.1 setting the power level

The power level defines the amount of heat produced by the stove and consequently directly affects fuel consumption.

To change the power level use the (◀ ▶) buttons to go to the power menu 🔥

- Use the (+ -) buttons to scroll the submenu
- Select submenu “1” and confirm by pressing (↔).
- The power level value will flash; set the value using the (+ -) buttons (1 minimum,....5 maximum)
- Press (↔) to confirm the settings.

1.3.2 Setting the temperature

Different temperature values can be set depending on the boiler’s configuration:

- Use the (◀ ▶) buttons to go to the temperature menu 🌡️ and press (↔);
- The current value will flash; change it using the (+ -) buttons
- Press (↔) to confirm the settings.

Water temperature (configurations 1 only): setting this value changes the desired hot water outlet temperature.

Room temperature (configuration 2 and 5 only): setting this value defines the desired room temperature, read directly by a probe fitted on the boiler.

Storage temperature (configurations 3 and 4 only): identifies the minimum desired temperature inside the storage tank.

1.3.3 Changing the ventilation (only if connected, in configuration 5, to the Everspring system)

To change the value of ventilation of the Everspring system:

- Use the (◀ ▶) buttons to go to the fan menu 🌀 and press (↔);
- The fan speed value will blink; modify the value by pressing (+ -);
 - “1” minimum,...., “5” maximum;
 - “Auto” = automatic functioning (the stove will set automatically the fan speed and the stove power according to the room temperature);
 - “Hi” = ultrarapid functioning (to use only in the case you need to quickly heat the room);
- press the button (↔) to confirm the data you set.

2 PRELIMINARY OPERATIONS

2.1 LOADING THE PELLETS

The first operation to be performed before starting the appliance is to fill the hopper with fuel (pellets).

The pellets are loaded into in the hopper using a scoop.

Do not empty the sack directly into the hopper so as to avoid loading sawdust or other foreign bodies that may affect proper stove operation and avoid spilling pellets outside of the hopper.



Make sure the hopper lid is well closed again after having loaded the pellets. A safety switch (just for the models that are equipped with it) makes sure that the pellet tank lid has been closed properly (IS in fig. 2.1) and triggers a stove alarm in case the pellet tank lid stays open for more than one minute while the stove is still working.

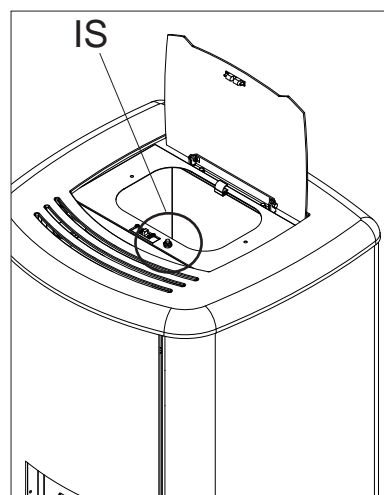

Fig. 2.1

2.2 POWER SUPPLY

Plug the stove into the mains power supply, move the power switch at the rear of the stove to position "I" (Fig. 2.2). If the connections are correct the stove will emit a series of intermittent beeps, the display will come on.



If not using the appliance for an extended period, the switch at the rear of the stove should be moved to position (O).

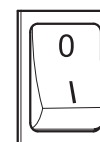

Fig. 2.2

2.3 INITIAL SETTINGS

Current date and time need to be set before using the stove.











2.3.1 Time and Date setting

To set the date:

- a) Use the ◀ ▶ buttons to go to the setup menu ⚙ and press ↵;
- b) Use the + button to select the password "7" and then press ↵ to confirm;
- c) Use the + button to scroll to and select submenu [3] and press ↵ to confirm;
- d) The hour value will flash; set the value using the + - buttons and press ▶;
- e) The minutes value will flash; set the value using the + - buttons and press ▶;
- f) The day value will flash; set the value using the + - buttons and press ▶;
- g) The month value will flash; set the value using the + - buttons and press ▶;
- h) The year value will flash; set the value using the + - buttons and press ▶;
- i) The current weekday value will flash (Monday = 1... Sunday = 7); set the value using the + - buttons;
- j) Press ↵ to confirm the settings.











2.3.2 Setting the display mode

The data shown on the display when this is in standby mode can be set.

- a) Use the arrow buttons   to go to the setup menu  and then press .
- b) Use the  button to select the password "7" and then press  to confirm;
- c) Use the  button to scroll to and select submenu [12] and press  to confirm;
- d) Set one of the following values using the  and  buttons:
 - "OFF" • The display remains on the last operation set by the user;
 - "1" • All operating parameters are displayed cyclically;
 - "2" • The room or water probe temperature is shown, based on the type of configuration
 - "3" • The current time is shown
 - "4" • The operating autonomy in hours before having to refill the hopper is shown, If the function "filling" has been activated.
- e) Press  to confirm the settings.











2.3.3 Setting the display brightness

Display brightness when in standby mode can be set.

- a) Use the arrow buttons   to go to the setup menu  and then press .
- b) Use the  button to select the password "7" and then press  to confirm;
- c) Use the  button to scroll to and select submenu [11] and press  to confirm;
- d) Set the desired brightness (OFF, 1 ... 5) using the   buttons and press  to confirm.

2.3.4 Setting the volume











The volume of the buzzer can be set based on requirements:

- a) Use the arrow buttons   to go to the setup menu  and then press .
- b) Use the  button to select the password "7" and then press  to confirm;
- c) Use the  button to scroll to and select submenu [13] and press  to confirm;
- d) Set the desired volume (OFF, 1 to 5) using the   buttons and press  to confirm.

2.3.5 Improving the combustion

A good combustion depends on several factors (type of installation, operation and maintenance conditions, type of pellet etc ..)

If at the end of combustion in the brazier are many waste, it is advisable to change the combustion configurations (increasing the value) to find the most satisfactory solution.

- a) Use the arrow buttons   to go to the setup menu  and then press .
- b) Use the  button to select the password "7" and then press  to confirm;
- c) Use the  button to scroll to and select submenu [14] and press  to confirm;
- d) Set one of the following values using the  and  buttons:
 - "1"
 - "2"
 - "3"
- e) Press  to confirm the settings.

3 STOVE OPERATION

3.1 STARTING THE STOVE

 Before every ignition, be sure that burning pot is completely empty and properly positioned in its seat.

To start the stove hold the  button for several seconds.

The flame icon will start flashing during the ignition stage until remaining on steady when the stove has started.

 Automatic stove ignition: the stove comes with an automatic device that starts the pellet stove without using other traditional fire lighters.

 Avoid lighting the flame manually if the stove's automatic ignition system is not working correctly.

 When the stove is started the first time, unpleasant odours or smoke may be generated, caused by evaporation or drying of certain materials used. This phenomenon will gradually disappear.

The room should be well ventilated when starting the stove the first few times.

3.2 MODIFYING THE PARAMETERS

The stove operating parameters can be modified as described.

 The values set will be retained until next modified, even when the stove is switched off or unplugged from the power supply.

3.3 SWITCHING OFF

To switch the stove off hold the  button for a few seconds; the flame icon will switch off.

 To start the stove again it's recommended to wait for the stove to cool down completely.

 The stove should only be switched off following the procedure described above. Never switch the stove off by unplugging it from the power supply.

3.4 OPERATION WITH ROOM THERMOSTAT

When the stove is controlled by an external thermostat (or timer thermostat), the installer must have set configuration 1.

In this configuration the stove switches off when reaching the external thermostat setting or alternatively modulates output (that is, the stove attempts to maintain the desired temperature while minimising fuel consumption) when reaching the set water temperature.

The stove switches on again automatically when the temperature falls below the value set on the external thermostat (circuit closed).

 **On first ignition, or if the stove has been**



switched off manually ( button), the stove needs to be started directly from the control panel.

The stove will go off automatically even in the case the water temperature keeps growing notwithstanding the modulation mode. In this case the stove will ignite only if the difference between the selected and actual temperature is over 20°C. Therefore, if you choose this configuration, we suggest that you select a high water temperature (e.g.. 70°C).

3.5 OPERATION WITH ROOM PROBE ON THE BOILER

The boiler can be switched on/off manually or in programmed mode.

In this type of configuration, the boiler modulates output according to the room temperature read by the probe on the boiler (that is, the boiler attempts to maintain the desired temperature while minimising fuel consumption).

If the user has enabled the "Eco-mode" function under submenu [7] of the setup menu , the boiler rather than modulating its output, switches off when reaching the set temperature, and switches on again when the room temperature falls below the delta set in submenu [7] of the setup menu .



The desired room temperature can be set in temperature menu .

Submenu [6] of the setup menu  can be used to set the desired water outlet temperature (the best temperature for the heating system in question should be suggested by the heating system installer).

3.6 OPERATION IN COMBINATION WITH A STORAGE TANK

For operation in combination with a storage tank, the installer will have set configuration 3 or 4, depending on whether the storage tank is with or without a coil inside.

The boiler is controlled based on the temperature read by the probe in the storage tank.

When reaching the storage tank temperature set in the temperature menu  the boiler switches off, and switches on again if the temperature falls below the delta set in submenu [8] of the setup menu .

The frost protection function can also be set in this configuration.

3.7 OPERATION IN CONJUNCTION WITH THE "EVERSPRING" SYSTEM



Before using the product in combination with the "Everspring" system, read all the documentation supplied with the system and ensure having received adequate instructions from the installer on operation of this system and of any cooling units present.

When the stove is connected to the Everspring system, it must be set in configuration 5.







In this configuration, it can be switched on/off manually or in scheduled mode.

The stove can operate in winter mode (default) or in summer mode, if the Everspring system also includes a cooling unit.



Via the ventilation menu , the user can change the speed of the hot/cold air through the Everspring unit.

3.7.1 Winter Mode

To switch from summer to winter mode, with the stove off (cold) but still connected to the mains:

- a) Using the keys   navigate to the power menu  and press the key ;
- b) The "SUN" value will flash; change it with the key  until a value of between 1 and 5 is reached;
- c) Press the key  to confirm your choice.

In this type of configuration, the boiler modulates the power according to the ambient temperature read by the probe on the Everspring system (i.e. the boiler aims to maintain the desired temperature while minimising consumption).







Where the user has enabled the "Eco-mode" function in the sub-menu [7] of the set-up menu , the boiler, instead of modulating, will switch off when the temperature set is reached and switches back on again when the ambient temperature drops below the delta specified in the sub-menu [8] of the set-up menu .

It is possible to set the desired temperature in ambient in the temperature menu .

In sub-menu [6] of the set-up menu  it is possible to set the desired temperature of the supply water (it is advisable to set this temperature at around 70°C).



3.7.2 Summer Mode (to be used if there is a cooling unit combined with Everspring)

To switch to summer mode, with the stove off (cold), but connected to the mains, simply:

- a) Using the keys   navigate to the power menu  and press the key ;
- b) The current value will flash; change it with the key  until the "SUN" value is reached;
- c) Press the key  to confirm your choice.



Set the desired summer temperature in ambient in the temperature menu .

In this mode, the stove will activate the cooling unit when the ambient temperature exceeds the temperature set in the temperature menu  and switches off the unit when the ambient temperature drops below the delta specified in the sub [8] of the set-up menu .



After setting summer mode, to activate its operation, press the power key  on the control panel.

4 FUNCTIONS AVAILABLE

4.1 TIMER FUNCTION

It's possible to set, enable and assign to the various days of the week, customised programs for automatically switching the stove on and off.

Up to six customised programs can be set.

For each program, the following can be set: on time, off time and desired temperature.

Up to three programs can be assigned for each day of the week.

The days of the week are identified by numbers: Monday = "d1", Tuesday = "d2";...; Sunday = "d7"..

4.1.1 Setting the programs

- a) Use the arrow buttons to go to the setup menu and then press ;
- b) Use the button to select the password "7" and then press to confirm;
- c) Select submenu [2] and confirm by pressing ;
- d) Use the buttons to scroll the programs P1...P6;
- e) The on hours value will flash; set the value using the buttons and press ;
- f) The minutes value will flash; set the value using the buttons and press ;
- g) The off hours value will flash; set the value using the buttons and press ;
- h) The minutes value will flash; set the value using the buttons and press ;
- i) The desired temperature value will flash; set the value using the buttons and press ;
- j) Press to confirm the settings.

4.1.2 Assigning the programs to specific days

This function can be used to assign up to three different programs to a certain day.

- a) Use the arrow buttons to go to the setup menu and then press ;
- b) Use the button to select the password "7" and then press to confirm;
- c) Select submenu [1] and confirm by pressing ;
- d) Use the buttons to choose the day [d1]...[d7] to assign the programs to
- e) Select this using the button;
- f) The value of the first program to assign will flash: P1...P6 or "OFF" to disable;
- g) Set the value using the buttons and press ;
- h) The value of the second program to assign will flash: P1...P6 or "OFF" to disable;
- i) Set the value using the buttons and press ;
- j) The value of the third program to assign will flash: P1...P6 or "OFF" to disable;
- k) Set the value using the buttons and press to confirm the settings.

4.1.3 Enabling/disabling the timer

- a) Use the arrow buttons to go to the Timer menu ;
- b) Select this using the button;
- c) Use the buttons to scroll and select: "ON" to enable the timer or "OFF" to disable it;
- d) Press to confirm the selection.

When the timer is enabled, the icon will be on steady, indicating that the timer is active.

4.2 “ECO MODE” SAVING FUNCTION

Enabling this function means that the stove switches off when reaching the desired room temperature. If this function is not enabled, the stove modulates operation so as to maintain the desired temperature while consuming the least amount of fuel possible. The “Eco Mode” function is only available in configuration 2.

To enable/disable the function:

- Use the arrow buttons to go to the setup menu and then press ;
- Use the button to select the password “7” and then press to confirm;
- Select submenu [7] and confirm by pressing .
- Set one of the following values using the buttons:
 - Eco → Enable “Eco Mode” function
 - Off → Disable “Eco Mode” function
- Press to confirm the settings.

4.3 RESTARTING AFTER A POWER FAILURE

In the event of power failures, the stove will switch back on automatically, checking the safety conditions, when power returns.

4.4 “LOCK KEYPAD” FUNCTION

This function is used to disable the use of the control panel and avoid accidental modifications.

To enable/disable the function:

- Use the arrow buttons to go to the setup menu and then press .
- Use the button to select the password “7” and then press to confirm;
- Select submenu [10] and confirm by pressing .
- Use the buttons to set one of the following values:
 - “Off” Lock keypad disabled
 - “Lo” Only the on/off button is enabled
 - “Hi” Lock keypad enabled
- Press to confirm the settings.

4.5 FROST PROTECTION FUNCTION

In configurations 2, 3 and 4 a minimum temperature can be set below which the boiler will switch on (outside of the set time bands).

Configuration 2:

To set the “frost protection” temperature:

- Use the arrow buttons to go to the setup menu and then press .
- Use the button to select the password “7” and then press to confirm;
- Select submenu [9] and confirm by pressing .
- The value will flash; change it using the buttons (OFF; 3...20°C);
- Press to confirm the settings.

Configuration 3 and 4:

To set the “frost protection” temperature:

- Use the arrow buttons to go to the setup menu and then press .
- Use the button to select the password “7” and then press to confirm;
- Select submenu [9] and confirm by pressing .
- The value will flash; change it using the buttons (OFF; 3...50°C);
- Press to confirm the settings.











Setting the value to “OFF” in step d disables the function.

4.6 RESTART DELTA FUNCTION

Restart delta (configurations 2, 3, 4 and 5) is the number of degrees centigrade below the switch-off temperature at which the stove switches on again automatically. For example, if the stove is set to switch off at 20°C (Eco Mode active) and "Restart delta" is set to 4°C, the stove will switch on again when the temperature measured is less than or equal to 16°C.











Configuration 2 and 5:

To set the restart delta value:

- Use the arrow buttons   to go to the setup menu  and then press .
- Use the  button to select the password "7" and then press  to confirm;
- Select submenu [8] and press  to confirm;
- The value will flash; change it using the  and  buttons (0,5 ... 5,0°C);
- Press the  button to confirm the set value.

Configuration 3 and 4:











To set the restart delta value:

- Use the arrow buttons   to go to the setup menu  and then press .
- Use the  button to select the password "7" and then press  to confirm;
- Select submenu [8] and press  to confirm;
- The value will flash; change it using the  and  buttons (0 ... 40°C);
- Press the  button to confirm the set value.

4.7 MANUAL ACTIVATION OF THE LOAD SYSTEM

In case of first use (pellet tank initially empty) or to test operation of the load unit, manual activation of loading is possible.

On the control panel of the stove:



- Using the arrow keys   navigate to the set-up menu  and press the key .
- Select password "7" with the key  and confirm with the key .
- Scroll with the key  and select sub-menu [31] ;
- Select password "54" with the key  and confirm with the key .
- Holding the key  the load system will activate and the display will show the incremental bars
- Releasing the key will end the load operation.

Attention!

- This function is only active when the stove is off and cold.
- Before switching on again, ensure that there are no pellets in the grate.

5 ALARM MANAGEMENT

If a malfunction occurs, the following procedure is activated:

- audible alarm (beep);
- one of the following system LEDs come on:    ;
- if the problem concerns an error, the stove will switch off.

Pressing and holding the “cancel” button  shows the error code on the display:

ERROR/ WARNING CODE	DESCRIPTION	POSSIBLE CAUSES	LED
E001	Faulty control panel	Control panel fault	
E002	Remote control signal communication error	Control panel fault	
E004	Communication error	Connection cable between board and control panel interrupted or detached. If this appears when changing configuration, ignore the error	
E101	Failed ignition error Outlet water temperature too high	No pellets Pellet quality Faulty ignition system Burn pot dirty Problems with the heating system Problems with the pump	
E105	Temperature probe malfunction	Faulty return water temperature probe	
E106	Temperature probe malfunction	Faulty buffer tank temperature probe	
E108*	Safety error	Door or loading hatch open	
E108**	Thermal safety	Problems with the heating system Problems with the pump Problems with overheating in the pellet hopper	
E109*	Incorrect pressure or thermal cutout	Flue system dirty Seals worn Insufficient combustion air Heating system malfunction Circulation pump malfunction Pellet tank overheating	
E109**	Pressure error	Flue gas exhaust system dirty Seal gaskets worn Insufficient combustion air	
E110	Temperature probe malfunction	Faulty outlet water temperature probe Faulty air temperature probe	
E111	Flue gas temperature probe malfunction	Faulty flue gas temperature probe	
A001	Low pellet level (<i>icon flashing</i>)	Pellets running out	
A002	Scheduled maintenance warning (<i>icons flashing</i>)	The stove periodically requires maintenance to be performed by a qualified technician	
A007	Pressure sensor malfunction (<i>icon flashing</i>)	Pressure sensor or board fault.	
----	Clean stove	Combustion chamber, burn pot or flue gas exhaust system dirty. Pressure measuring tubes detached or blocked. Combustion air intake blocked.	
----	Failed ignition error	No pellets; Faulty ignition heater; Worn gaskets; Incorrect burn pot position	

* Only in the stoves equipped with micro safety-switches on the firebox door and on the pellet hopper lid.

** Only in the stoves without micro safety-switches on the firebox door and on the pellet hopper lid.

After having checked the type of message, the alarm can be reset by pressing the on/off button  for a few moments.

If the error code is “E108 or E109”, before resetting the alarm, manually reset the thermostat located on the rear of the stove (Fig. 11.1). Then the stove can be started again.



Fig.5.1

INHALT

1 BEDIENFELD

- 1.1 BESCHREIBUNG
- 1.2 BENUTZUNG DES BEDIENPANELS
- 1.3 BETRIEBSPARAMETER

2 ERSTE SCHRITTE

- 2.1 PELLETZUFÜHRUNG
- 2.2 STROMVERSORGUNG
- 2.3 ANFÄNGLICHE EINSTELLUNGEN

3 GEBRAUCH DES OFENS

- 3.1 EINSCHALTEN
- 3.2 BEARBEITEN DER PARAMETER
- 3.3 AUSSCHALTEN
- 3.4 BETRIEB MIT RAUMTHERMOSTAT
- 3.5 BETRIEB MIT RAUMTEMPERATURFÜHLER AM OFEN
- 3.6 BETRIEB IN KOMBINATION MIT EINEM SPEICHER
- 3.7 BETRIEB IN KOMBINATION MIT DEM „EVERSPRING“-SYSTEM

4 VERFÜGBARE FUNKTIONEN

- 4.1 TIMER-FUNKTION
- 4.2 SPARFUNKTION „ECO MODE“
- 4.3 WIEDEREINSCHALTEN NACH STROMAUSFALL
- 4.4 FUNKTION „TASTATURSPERRE“
- 4.5 FROSTSCHUTZFUNKTION
- 4.6 FUNKTION EINSCHALTDIFFERENZ
- 4.7 MANUELLE AKTIVIERUNG DES ZUFÜHRSYSTEMS

5 VERWALTUNG DER ALARMMELDUNGEN

1 BEDIENFELD

Vor dem Lesen der Anleitung die Beschreibung des Heizofens zurate ziehen, die im beiliegenden Handbuch enthalten ist.

1.1 BESCHREIBUNG

Bestandteile des Bedienpanels:

A) obere Anzeigeleiste mit den Status-LEDs und den hinterleuchteten Symbolen der einzelnen Funktionen;

B) LED-Display;

C) Einschalttaste;

D) Taste „Abbrechen“ und „Fehleranzeige“;

E) zwei Pfeiltasten für die Navigation durch die verschiedenen Funktionen;

F) zwei Tasten (+) und (-) zum Öffnen der Untermenüs und Bearbeiten der Betriebsparameter;

G) eine Eingabetaste (↵) für die Bestätigung des Parameters oder der Auswahl

 Alle Tasten sind kapazitiv, d.h. zur Aktivierung müssen sie nicht gedrückt, sondern lediglich berührt werden.

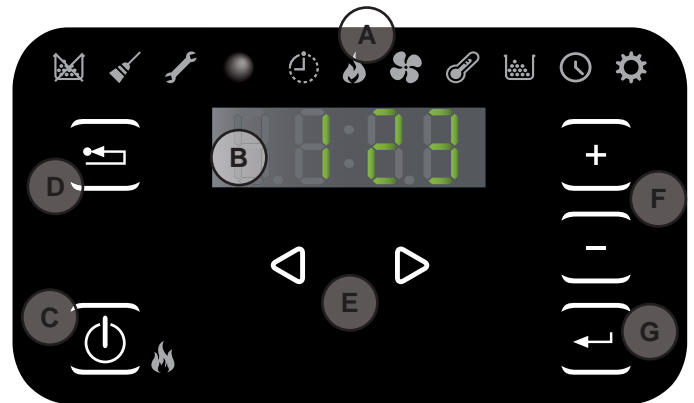















Fig. 1.1

1.1.1 Status-LED

SYMBOL	MELDUNG	BESCHREIBUNG
	Pellets fast leer	Der Pelletbehälter muss gefüllt werden.
	Wartung	Ein Wartungseingriff muss durchgeführt werden
	Service	Zeigt das Vorliegen eines Fehlers an
	Empfänger der Fernbedienung	OPTIONAL
	Timer aktiv	Zeigt an, ob die Funktion Timer aktiv ist.
	Status-LED (neben der Taste )	Led mit Dauerlicht: Ofen eingeschaltet und in Betrieb Led blinkt: Ofen in Einschaltphase oder Standby Led erloschen: Ofen ausgeschaltet

1.1.2 Beschreibung der menüs

SYMBOL	FUNKTION	BESCHREIBUNG	WERTE
	Leistung	Einstellung der Betriebsstufe	1..5
	Lüftung	Einstellung der Lüftergeschwindigkeit, wenn der Ofen mit Konfiguration 5 an das Everspring-System angeschlossen ist	1..5; Auto; Hi
	Temperatur	Es zeigt die Temperatur die bei der Sonde* gelesen wird und erlaubt man die gewünschte Temperatur einzustellen. *Konfiguration1: Vorlaufsonde; Konfig.2-5: Raum-Konfiguration; Konfiguration 3-4: Externe Sonde/Puffer Sonde.	Konfig.1: 65..80 °C Konfig.2-5: 10.. 48 °C Konfig.3-4: 45..75 °C
	Brennstoff	Diese Funktion wird nicht verwendet.	
	Timer	Timer aktivieren oder deaktivieren. Wenn er aktiviert ist, wird das Symbol dauerhaft angezeigt 	ON - OFF

SYMBOL	FUNKTION	UNTERMENÜ	BESCHREIBUNG	WERTE	
	Setup	[1]	Wochentimer	Zuweisung der Programme (max. 3) an die verschiedenen Wochentage	[d1] ... [d7]
		[2]	Programme	Menü der Programmeinstellung	[P1] ... [P6]
		[3]	Uhrzeit / Datum	Uhrzeit und Datum einstellen	
		[4]	Verbleibende Stunden	Anzeige der verbleibenden Stunden bis zur empfohlenen Wartung. Mit dem Wert "Hi" wird eine Zahl über 999 Stunden angegeben.	
		[5]	Systeminformationen	Anzeige der aktuellen Software-Version	
		[6]	Wassertemperatur	Hier können Sie die gewünschte Temperatur für das Wasser gesetzt (nur in der Konfiguration 2-5).	60 ... 80°C
		[7]	Funktion Eco	Schaltet den Modus Eco frei bzw. sperrt ihn, wodurch das Ausschalten und Wiedereinschalten anhand der Raumtemperatur automatisch erfolgt (Nur in der Konfiguration 2-5).	OFF; Eco
		[8]	Einschaltdifferenz	Unterhalb der Ausschalttemperatur liegender Wert in Grad Celsius, bei dessen Überschreitung der Ofen automatisch wieder eingeschaltet wird (Außer in Konfiguration 1).	0,5 ... 5,0°C 0 ... 40°C
		[9]	Frostschutztemperatur	Mindesttemperatur, bei deren Unterschreitung der Ofen eingeschaltet wird (Außer in Konfiguration 1).	OFF; 3 ... 20°C OFF; 3 ... 50°C
		[10]	Tastatursperre	Modus Tastatursperre einstellen	OFF; Lo; Hi
		[11]	Displayhelligkeit	Helligkeitsgrad des Displays einstellen	OFF; 1 ... 5
		[12]	Displaymodus	Anzeigemodus der Daten einstellen	OFF; 1 ... 4
		[13]	Summerlautstärke	Lautstärke des Signaltons einstellen	OFF; 1 ... 5
		[14]	Verbrennung	Ändern der Verbrennungskonfigurationen	1 ... 3
		[30]	Installateur-Menü	Ofenkonfiguration bearbeiten/anzeigen	PWD: "54"
		[31]	Manuelles Laden der Schnecke	Manuelle Aktivierung des Pelletszuführsystems	PWD: "54"
[33]	Versorgung Pumpe	Menü für den Technischen Kundendienst	PWD: "54"		
[34]	Aktivieren / Deaktivieren	Menu di competenza del centro di assistenza	PWD: "54"		
[40]	Modulation Pumpe	Menü für den Technischen Kundendienst			

Die Untermenüs [30] und [40] des Menüs Setup sind passwortgeschützt und sind ausschließlich dem Kundendienst vorbehalten

1.2 BENUTZUNG DES BEDIENPANELS

- Mit den Pfeiltasten (◀) (▶) wird der Cursor zwischen den verschiedenen, jeweils aufleuchtenden Menüs bewegt.
- Wird der Cursor auf eine bestimmte Funktion gesetzt, können mit den Tasten (+) (-); die eventuellen Untermenüs aufgerufen werden; um einen Parameter zu ändern, die Taste (↵) antippen und seine Werte mit den Tasten (+) (-) ändern. Mit der nochmaligen Betätigung der Taste (↵) wird die Änderung bestätigt.
- Im Allgemeinen können alle blinkenden Werte mit den Tasten (+) (-) geändert werden.
- Die Taste „Abbrechen“ (⏪) gestattet, um eine Menüebene zurückzukehren; durch anhaltendes Drücken dieser Taste wird ein eventueller Alarm- oder Fehlercode auf dem Display angezeigt.

1.3 BETRIEBSPARAMETER

Der Ofenbetrieb wird von den benutzerdefinierten Leistungs- und Temperaturparametern bestimmt.

1.3.1 Leistungsstufe ändern

Die Leistung definiert die vom Ofen erzeugte Wärmemenge und hat daher direkten Einfluss auf den Verbrauch. Zur Änderung der Leistung den Cursor mit den Tasten (◀) (▶) auf das Menü Leistung  setzen.

- a) Mit den Tasten (+) (-) durch das Untermenü blättern.
- b) Das Untermenü "1" wählen und mit der Taste (↵) bestätigen.
- c) Der Leistungswert blinkt; den Wert mit den Tasten (+) (-) ändern (1 kleinste Stufe,...,5 Höchststufe).
- d) Die eingegebenen Daten mit der Taste (↵) bestätigen.

1.3.2 Temperatur ändern

Je nach Installationskonfiguration des Ofens können verschiedene Temperaturwerte geändert werden:

- a) Mit den Tasten (◀) (▶) das Menü Temperatur  aufrufen und die Taste (↵) drücken;
- b) Der aktuelle Wert blinkt; Wert mit den Tasten (+) (-) ändern;
- c) Den eingegebenen Wert mit der Taste (↵) bestätigen.

Wassertemperatur (nur Installationskonfigurationen 1): Durch Ändern dieses Wertes wird die gewünschte Vorlauftemperatur des Warmwassers durch den Ofen geändert.

Raumtemperatur (nur Installationskonfigurationen 2 und 5): Durch Ändern dieses Wertes wird die Temperatur festgelegt, die im Raum erreicht werden soll, und die direkt von einem am Ofen eingebauten Temperaturfühler gemessen wird.

Speichertemperatur (nur Installationskonfigurationen 3 und 4): Dies ist die Mindesttemperatur, die im Speicher gehalten werden soll.

1.3.3 Änderung der Ventilation (nur wenn mit Konfiguration 5 an das Everspring-System angeschlossen)

Zum Ändern des Wertes der Ventilation und des Everspring-Systems:

- a) Mit den Tasten (◀) (▶) das Menü Lüftung  aufrufen und die Taste (↵) drücken;
- b) Der Lüftung-Wert wird blinken; den gewünschten Wert mit den Tasten (+) (-) ändern
 - "1" Minimum ,...,"5" Maximum;
 - "Auto" = automatisches Betrieb (der Ofen wird die Geschwindigkeit des Raumluftgebläse anhand der Raumtemperatur einstellen);
 - "Hi" = ultraschnelles Betrieb (diese Funktion sollten Sie lediglich benutzen falls Sie das Raum schnell heizen möchten);
- c) Die gewählte Daten mit der Taste (↵) bestätigen.

2 ERSTE SCHRITTE

2.1 PELLETZUFÜHRUNG

Bevor das Gerät eingeschaltet wird, muss als erstes der Brennstoffbehälter (Pellets) gefüllt werden.

Die Pellets müssen mit einer Schaufel in den Behälter gefüllt werden.

Schütten Sie die Pellets nicht direkt aus dem Sack in den Behälter, um nicht versehentlich Sägemehl oder andere Fremdkörper einzufüllen, die den einwandfreien Betrieb des Ofens beeinträchtigen könnten, und um keine Pellets außerhalb des Behälters zu verstreuen.



Nach dem Einfüllen der Pellets muss die Abdeckung des Brennstoffbehälters wieder gut verschlossen werden.

Ein Sicherheitsschalter (nur bei den Modellen, die einen solchen vorsehen) prüft, ob sie korrekt verschlossen ist. (IS in Abb. 2.1)

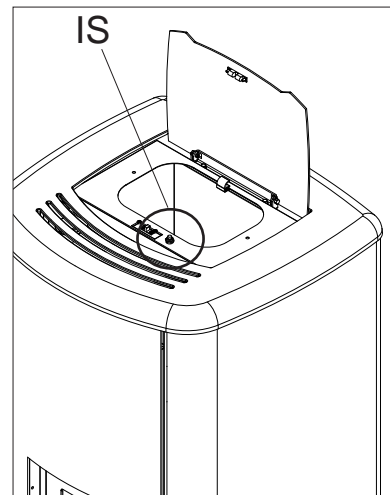

Fig. 2.1

2.2 STROMVERSORGUNG

Den Ofen an das Stromnetz anschließen, den Einschalter an der Ofenrückseite antippen und auf „I“ stellen (Abb. 2,2). Wenn der Anschluss korrekt ist, gibt der Ofen mehrere aussetzende Signaltöne ab und das Display wird eingeschaltet.



Bei längerem Stillstand wird empfohlen, den Schalter an der Ofenrückseite auf OFF (O) zu stellen.

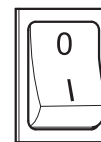

Fig. 2.2

2.3 ANFÄNGLICHE EINSTELLUNGEN

Vor dem Gebrauch des Ofens müssen das Datum und die aktuelle Uhrzeit eingestellt werden.

2.3.1 Uhrzeit und datum einstellen

Zur Änderung des Datums:

- a) Mit den Tasten ◀ ▶ das Menü Setup aufrufen und die Taste ← drücken;
- b) Mit der Taste + das Passwort "7" anwählen und mit der Taste ← bestätigen;
- c) Mit der Taste + scrollen, das Untermenü [3] anwählen und mit der Taste ← bestätigen;
- d) Die Stunden blinken; den Wert mit den Tasten + - ändern und die Taste ▶ antippen;
- e) Die Minuten blinken; den Wert mit den Tasten + - ändern und die Taste ▶ antippen;
- f) Der Tag blinkt; den Wert mit den Tasten + - ändern und die Taste ▶ antippen;
- g) Der Monat blinkt; den Wert mit den Tasten + - ändern und die Taste ▶ antippen;
- h) Das Jahr blinkt; den Wert mit den Tasten + - ändern und die Taste ▶ antippen;
- i) Der aktuelle Wochentag blinkt (Montag = 1 ... Sonntag = 7); den Wert mit den Tasten + - ändern;
- j) Die eingegebenen Daten mit der Taste ← bestätigen.

2.3.2 Displaymodus einstellen

Der Benutzer kann einstellen, was auf dem Display angezeigt werden soll, wenn dieses auf Standby ist.

- a) Mit den Tasten ◀ ▶ das Menü Setup  aufrufen und die Taste ⏪ drücken;
- b) Mit der Taste + das Passwort "7" anwählen und mit der Taste ⏪ bestätigen;
- c) Mit der Taste + scrollen, das Untermenü [12] anwählen und mit der Taste ⏪ bestätigen;
- d) Mit den Tasten + und - einen der folgenden Werte eingeben:
 - "OFF" • Das Display wird die letzte vom Benutzer betätigte Visualisierungsart zeigen;
 - "1" • Alle Funktionsparameter werden zyklisch gezeigt;
 - "2" • Die Temperatur wird gezeigt (Raum oder Wassersonde, es hängt mit der Konfiguration zusammen);
 - "3" • Die aktuelle Zeit wird gezeigt;
 - "4" • Die Betriebsautonomie wird gezeigt, welche auf die fehlenden Stunden vor der Wiederfüllung vom Pelletsbehälter hinweist, Ob die Funktion Nachfüllung eingestellt ist.
- e) Die eingegebenen Daten mit der Taste ⏪ bestätigen.

2.3.3 Display-helligkeit einstellen

Der Benutzer kann einstellen, wie stark die Display-Helligkeit im Standby-Modus gedämpft wird.

- a) Mit den Tasten ◀ ▶ das Menü Setup  aufrufen und die Taste ⏪ drücken;
- b) Mit der Taste + das Passwort "7" anwählen und mit der Taste ⏪ bestätigen;
- c) Mit der Taste + scrollen, das Untermenü [11] anwählen und mit der Taste ⏪ bestätigen;
- d) Mit den Tasten + und - den gewünschten Helligkeitswert einstellen (OFF, 1 ... 5) und mit der Taste ⏪ bestätigen;

2.3.4 Summerlautstärke einstellen

Die Lautstärke des Signaltons kann nach Bedarf eingestellt werden:

- a) Mit den Tasten ◀ ▶ das Menü Setup  aufrufen und die Taste ⏪ drücken;
- b) Mit der Taste + das Passwort "7" anwählen und mit der Taste ⏪ bestätigen;
- c) Mit der Taste + scrollen, das Untermenü [13] anwählen und mit der Taste ⏪ bestätigen;
- d) Mit den Tasten + und - die gewünschte Lautstärke einstellen (OFF, 1 ... 5) und mit der Taste ⏪ bestätigen;

2.3.5 OPTIMISIERUNG DER VERBRENNUNG

Eine optimale Verbrennung ist im Zusammenhang mit verschiedene Faktoren (Installation Art, Benutzung Art und Wartung, Pellet Eigenschaften, usw.).

Sollten in der Brennschale, nach der Verbrennung, viele Asche Reste bleiben können die Verbrennung Einstellungen (Pellet Art) zwischen 2 weitere Einstellungen geändert werden.

- a) Mit den Tasten ◀ ▶ das Menü Setup  aufrufen und die Taste ⏪ drücken;
- b) Mit der Taste + das Passwort "7" anwählen und mit der Taste ⏪ bestätigen;
- c) Mit der Taste + scrollen, das Untermenü [14] anwählen und mit der Taste ⏪ bestätigen;
- d) Mit den Tasten + und - einen der folgenden Werte eingeben:
 - "1"
 - "2"
 - "3"
- e) Die eingegebenen Daten mit der Taste ⏪ bestätigen.

3 GEBRAUCH DES OFENS

3.1 EINSCHALTEN

 Entsichern Sie bevor jedes Start, das die Brennschale komplett leer, sauber und in seiner richtigen Position ist.

Zum Einschalten des Ofens die Taste  ein paar Sekunden lang gedrückt halten.

Während der Einschaltphase beginnt das Flammensymbol zu blinken und sobald der Ofen eingeschaltet ist, wechselt es auf Dauerlicht.

! Automatische Einschaltung: Der Ofen verfügt über eine automatische Vorrichtung, mit der die Pellets ohne Zuhilfenahme anderer, herkömmlicher Anzündhilfen angezündet werden können.

 Zünden Sie den Ofen nicht von Hand an, wenn das automatische Zündsystem nicht richtig funktioniert.

! Während der ersten Einschaltung des Ofens können unter Umständen unangenehme Gerüche oder Rauch auftreten, die durch das Verdunsten oder Trocknen einiger verwendeter Materialien verursacht werden. Dieses Phänomen verschwindet mit der Zeit.

Während der ersten Inbetriebnahmen sollten die Räume gut gelüftet werden.

3.2 BEARBEITEN DER PARAMETER

Die Betriebsparameter des Ofens können wie beschrieben geändert werden.

 Die eingestellten Werte werden bis zur nächsten Änderung beibehalten, auch wenn der Ofen ausgeschaltet oder vom Stromnetz getrennt wird.

3.3 AUSSCHALTEN

Zum Ausschalten des Ofens die Taste  ein paar Sekunden lang gedrückt halten; das Flammensymbol erlischt.

 Bevor der Ofen erneut eingeschaltet wird, sollte gewartet werden, bis er vollständig abgekühlt ist.

 Halten Sie sich beim Ausschalten des Ofens strikt an die obigen Anleitungen und schalten Sie ihn unter keinen Umständen durch Trennen der Spannungszufuhr aus.



3.4 BETRIEB MIT RAUMTHERMOSTAT

Wenn der Ofen von einem Raumthermostat (oder Uhrenthermostat) gesteuert wird, muss der Installationstechniker die Konfiguration 1 einstellen.

In dieser Konfiguration wird der Ofen ausgeschaltet, sobald die Wärmeanforderung des Raumthermostats erfüllt ist (Stromkreis offen), oder er moduliert seinen Betrieb bei Erreichen der

eingestellten Wassertemperatur (das heißt, der Ofen versucht, die gewünschte Temperatur bei geringstmöglichem Verbrauch zu halten).

Der Ofen wird automatisch wieder eingeschaltet, wenn die Temperatur unter den am Raumthermostat eingestellten Wert abfällt (Stromkreis geschlossen).

 **Bei erstmaliger Einschaltung oder wenn die Ausschaltung direkt am Ofen (Taste ) erfolgt ist, muss der Ofen direkt vom Bedienpanel eingeschaltet werden.**



Auch wenn trotz Modulation die Wassertemperatur weiterhin steigt, wird sich der Pelletofen ausschalten. In diesem Fall wird sich der Ofen nur dann wieder einschalten, wenn die Temperaturdifferenz zwischen Soll und Ist höher als 20°C ist.

Aus diesem Grund ist es ratsam, bei dieser Konfiguration die Soll-Wassertemperatur angemessen hoch einzustellen (z. B. 70°C).

3.5 BETRIEB MIT RAUMTEMPERATURFÜHLER AM OFEN

Der Ofen kann von Hand oder programmiert ein-/ausgeschaltet werden.

Bei dieser Konfigurationsart moduliert der Ofen die Leistung anhand der vom eingebauten Temperaturfühler gemessenen Raumtemperatur (das heißt, der Ofen versucht, die gewünschte Temperatur bei geringstmöglichem Verbrauch zu halten).

Falls der Benutzer im Untermenü [7] des Menü Setup , die Funktion „Eco-Mode“ aktiviert hat, moduliert der Ofen nicht, sondern schaltet bei Erreichen der Solltemperatur ab und erst dann wieder ein, wenn die Raumtemperatur unter den im Untermenü [7] des Menü Setup  angegebenen Differenzwert abfällt.

Die gewünschte Raumtemperatur kann im des Menüs Temperatur  eingestellt werden.

Über das Untermenü [6] des Menü Setup  kann die gewünschte Vorlauf-Wassertemperatur eingestellt werden (fragen Sie Ihren HLS-Installateur nach der optimalen Temperatur für Ihre Heizungsanlage).

3.6 BETRIEB IN KOMBINATION MIT EINEM SPEICHER

Für den Betrieb in Kombination mit einem Speicher muss der Installationstechniker abhängig davon, ob es sich um einen Speicher mit oder ohne interne Rohrwendel handelt, die Betriebskonfiguration 3 oder 4 einstellen.

Der Ofen wird anhand der vom Temperaturfühler im Speicher gemessenen Temperatur gesteuert.

Bei Erreichen der im Menü Temperatur  leingestellten Speicher-Temperatur wird der Ofen aus- und erst dann wieder eingeschaltet, wenn die

Speicher-Temperatur unter den im Untermenü [8] des Menü Setup  angegebenen Differenzwert abfällt.
In dieser Konfiguration kann auch die frostschutzfunktion eingestellt werden.

3.7 BETRIEB IN KOMBINATION MIT DEM „EVERSPRING“-SYSTEM



Vor der Verwendung des Produktes in Kombination mit dem „Everspring“-System vergewissern, die mit der Anlage gelieferte Dokumentation vollständig gelesen zu haben und vom Installateur der Anlage und ggf. Kühlanlage angemessen über die Funktionsweise informiert worden zu sein.







Wenn der Ofen an das Everspring-System angeschlossen wird, muss er auf die Konfiguration 5 eingestellt sein. In dieser Konfiguration kann er manuelle oder im programmierten Modus ein- und ausgeschaltet werden.

Der Ofen kann im (standardmäßigen) Winterbetrieb oder im Sommerbetrieb funktionieren, wenn das Everspring-System auch eine Kühleinheit vorsieht



Über das Menü der Ventilation , kann der Benutzer die Geschwindigkeit der warmen bzw. kalten Luft über die Einheit Everspring ändern.

3.7.1 Winterbetrieb

Zum Wechseln vom Sommer- in den Winterbetrieb bei mit Strom versorgtem und ausgeschaltetem (kalten) Ofen:

- Mit den Tasten   auf das Menü Leistung  gehen und die Taste  drücken;
- Der Wert „SUN“ blinkt; ihn mit der Taste  bis zu einem Wert zwischen 1 und 5 ändern
- Die Taste  drücken, um die Auswahl zu bestätigen.

Bei dieser Konfiguration moduliert der Heizkessel die Leistung entsprechend der Raumtemperatur, die von dem Fühler am Everspring-System gelesen wird (d.h. der Heizkessel versucht die gewünschte Temperatur zu halten und verbraucht so wenig wie möglich).







Hat der Benutzer die Funktion „Eco-mode“ im Untermenü [7] des Menüs Setup  aktiviert, schaltet sich der Heizkessel beim Erreichen der eingestellten Temperatur aus, anstatt zu modulieren und schaltet sich wieder ein, wenn die Raumtemperatur unter den Wert von Delta sinkt, der im Untermenü [8] des Menüs Setup  angegeben ist.

Es ist möglich, die gewünschte Raumtemperatur im Menü Temperatur  einzustellen.

Im Untermenü [6] im Menü Setup  kann die gewünschte Temperatur des Vorlaufwassers eingestellt werden (diese Temperatur sollte auf einen Wert um die 70 °C eingestellt werden).



3.7.2 Sommerbetrieb (wenn eine Kühleinheit in Kombination mit dem „Everspring“-System vorhanden ist)

Zum Wechseln zum Sommerbetrieb bei mit Strom versorgtem und ausgeschaltetem (kalten) Ofen:

- Mit den Tasten   auf das Menü Leistung  gehen und die Taste  drücken;
- Der aktuelle Wert blinkt; ihn mit der Taste  ändern, bis der Wert „SUN“ erreicht wird;
- Die Taste  drücken, um die Auswahl zu bestätigen.



Die gewünschte Raumtemperatur im Sommer im Menü Temperatur  einstellen.

In diesem Modus aktiviert der Ofen die Kühleinheit, wenn die Raumtemperatur die Temperatur  überschreitet, die im Menü Temperatur eingestellt ist und schaltet die Einheit aus, wenn die Raumtemperatur unter den Wert von Delta sinkt, der im Untermenü [8]] des Menüs Setup  angegeben ist.



Nach dem Einstellen des Sommerbetriebs muss zur Aktivierung des Betriebs die Taste für die Einschaltung  an der Bedientafel gedrückt werden.

4 VERFÜGBARE FUNKTIONEN

4.1 TIMER-FUNKTION

Mit dieser Funktion können die benutzerdefinierten Programme für das automatische Ein- und/oder Ausschalten des Ofens eingerichtet, aktiviert und den verschiedenen Wochentagen zugewiesen werden.

Es können bis zu sechs Programme eingerichtet werden.

Für jedes Programm kann eingestellt werden: Einschaltuhrzeit, Ausschaltuhrzeit und gewünschte Temperatur.

Jedem Wochentag können bis zu drei Programme zugewiesen werden.

Die Wochentage sind durch Zahlen gekennzeichnet: Montag = "d1", Dienstag = "d2";...; Sonntag = "d7".

4.1.1 Einstellung der programme

- Mit den Tasten ◀ ▶ das Menü Setup  aufrufen und die Taste ⏪ drücken;
- Mit der Taste + das Passwort "7" anwählen und mit der Taste ⏪ bestätigen;
- Das Untermenü [2] wählen und mit der Taste ⏪ bestätigen;
- Mit den Tasten + - durch die Programme P1...P6; blättern; mit der Taste ⏪ das Programm auswählen, das bearbeitet werden soll;
- Die Stunden der Einschaltuhrzeit blinken; den Wert mit den Tasten + - ändern und die Taste ▶ antippen;
- Die Minuten blinken; den Wert mit den Tasten + - ändern und die Taste ▶ antippen;
- Die Stunden der Ausschaltuhrzeit blinken; den Wert mit den Tasten + - ändern und die Taste ▶ antippen;
- Die Minuten blinken; den Wert mit den Tasten + - ändern und die Taste ▶ antippen;
- Der Wert der gewünschten Temperatur blinkt; den Wert mit den Tasten + - und ▶ ändern;
- Die eingegebenen Daten mit der Taste ⏪ bestätigen.

4.1.2 Zuordnen der programme an die tage

Mit dieser Funktion können einem bestimmten Tag bis zu drei verschiedene Programme zugewiesen werden.

- Mit den Tasten ◀ ▶ das Menü Setup  aufrufen und die Taste ⏪ drücken;
- Mit der Taste + das Passwort "7" anwählen und mit der Taste ⏪ bestätigen;
- Das Untermenü [1] wählen und mit der Taste ⏪ bestätigen.
- Mit den Tasten + - den Tag [d1]...[d7] wählen, dem die Programme zugewiesen werden sollen.
- Mit der Taste ⏪ auswählen.
- Der Wert des ersten zuzuweisenden Programmes blinkt: P1...P6 oder "OFF", um es zu deaktivieren.
- Den Wert mit den Tasten + - ändern und die Taste ▶ antippen.
- Der Wert des zweiten zuzuweisenden Programmes blinkt: P1...P6 oder "OFF", um es zu deaktivieren.
- Den Wert mit den Tasten + - ändern und die Taste ▶ antippen.
- Der Wert des dritten zuzuweisenden Programmes blinkt: P1...P6 oder "OFF", um es zu deaktivieren.
- Den Wert mit den Tasten + - ändern und die Taste ⏪ antippen, um die eingegebenen Daten zu bestätigen.

4.1.3 Timer aktivieren/deaktivieren

- Den Cursor mit den Pfeiltasten ◀ ▶ auf das Menü Timer  setzen.
- Mit der Taste ⏪ auswählen.
- Mit den Tasten + - blättern und wählen: "ON" zur Aktivierung des Timers oder "OFF" zur Deaktivierung.
- Die Taste ⏪ drücken, um die Auswahl zu bestätigen.

Wenn der Timer aktiviert ist, erscheint das Symbol  dauerhaft, um anzuzeigen, dass der Timer aktiv ist.

4.2 SPARFUNKTION "ECO MODE"

Bei Aktivierung dieser Funktion wird der Ofen bei Erreichen der gewünschten Raumtemperatur ausgeschaltet. Wenn diese Funktion nicht aktiviert ist, moduliert der Ofen seinen Betrieb, um die gewünschte Temperatur bei geringstmöglichem Verbrauch zu halten.

Die Funktion "Eco Mode" ist nur in Konfiguration 2 verfügbar.

Zur Aktivierung/Deaktivierung dieser Funkt:

- Mit den Tasten ◀ ▶ das Menü Setup  aufrufen und die Taste ⏪ drücken;
- Mit der Taste + das Passwort "7" anwählen und mit der Taste ⏪ bestätigen;
- Das Untermenü [7] wählen und mit der Taste ⏪ bestätigen.
- Mit den Tasten + - einen der folgenden Werte eingeben:
Eco → Die Funktion "Eco Mode" wird aktiviert;
Off → Die Funktion "Eco Mode" wird gesperrt.
- Die eingegebenen Daten mit der Taste ⏪ bestätigen.



4.3 WIEDEREINSCHALTEN NACH STROMAUSFALL

Bei einem Stromausfall wird der Ofen bei Rückkehr der Stromversorgung nach Prüfung der erforderlichen Voraussetzungen automatisch wieder eingeschaltet.

4.4 FUNKTION „TASTATURSPERRE“

Mit dieser Funktion kann die Verwendung des Bedienpanels blockiert werden, um unbeabsichtigte Änderungen zu vermeiden.

Zur Aktivierung/Deaktivierung dieser Funktion:

- Mit den Tasten ◀ ▶ das Menü Setup  aufrufen und die Taste ⏪ drücken;
- Mit der Taste + das Passwort "7" anwählen und mit der Taste ⏪ bestätigen;
- Das Untermenü [10] wählen und mit der Taste ⏪ bestätigen.
- Mit den Tasten + - einen der folgenden Werte eingeben:
"Off" Tastatursperre deaktiviert
"Lo" Nur die Ein-/Ausschalttaste bleibt aktiviert 
"Hi" Tastatursperre aktiviert
- Die eingegebenen Daten mit der Taste ⏪ bestätigen.

4.5 FROSTSCHUTZFUNKTION

In den Installationskonfigurationen 2, 3 und 4 kann eine Mindesttemperatur eingestellt werden, bei deren Unterschreitung der Ofen eingeschaltet wird (außerhalb der eingestellten Zeitintervalle).

Konfiguration 2:

Zur Änderung des Temperaturwerts „Frostschutz“:

- Mit den Tasten ◀ ▶ das Menü Setup  aufrufen und die Taste ⏪ drücken;
- Mit der Taste + das Passwort "7" anwählen und mit der Taste ⏪ bestätigen;
- Das Untermenü [9] wählen und mit der Taste ⏪ bestätigen;
- Der Wert blinkt; Wert mit den Tasten + - ändern (OFF; 3...20°C);
- Den eingegebenen Wert mit der Taste ⏪ bestätigen.

Konfiguration 3 und 4:

Zur Änderung des Temperaturwerts „Frostschutz“:

- Mit den Tasten ◀ ▶ das Menü Setup  aufrufen und die Taste ⏪ drücken;
- Mit der Taste + das Passwort "7" anwählen und mit der Taste ⏪ bestätigen;
- Das Untermenü [9] wählen und mit der Taste ⏪ bestätigen;
- Der Wert blinkt; Wert mit den Tasten + - ändern (OFF; 3...50°C);
- Den eingegebenen Wert mit der Taste ⏪ bestätigen.

Wenn unter Punkt d. der Wert "OFF" eingegeben wird, wird diese Funktion deaktiviert.

4.6 FUNKTION EINSCHALTDIFFERENZ

Wiedereinschaltdifferenz: (Installationskonfigurationen 2, 3, 4 und 5): Unterhalb der Ausschalttemperatur liegender Wert in Grad Celsius, bei dessen Überschreitung der Ofen automatisch wieder eingeschaltet wird. Wenn der Ofen zum Beispiel auf Ausschaltung bei 20°C eingestellt ist (Eco Mode aktiv) und eine „Einschaltdifferenz“ von 4°C eingegeben wird, schaltet sich der Ofen ein, sobald eine Temperatur von kleiner oder gleich 16°C gemessen wird.

Konfiguration 2 und 5:

Zur Änderung des Wertes der Einschaltdifferenz:

- Mit den Tasten ◀ ▶ das Menü Setup  aufrufen und die Taste ⏪ drücken;
- Mit der Taste + das Passwort „7“ anwählen und mit der Taste ⏪ bestätigen;
- Das Untermenü [8] anwählen und mit der Taste ⏪ bestätigen;
- Der Wert blinkt; den Wert mit den Tasten + und - ändern (0,5 ... 5,0°C);
- Die Taste ⏪ drücken, um den eingegebenen Wert zu bestätigen.

Konfiguration 3 und 4:

Zur Änderung des Wertes der Einschaltdifferenz:

- Mit den Tasten ◀ ▶ das Menü Setup  aufrufen und die Taste ⏪ drücken;
- Mit der Taste + das Passwort „7“ anwählen und mit der Taste ⏪ bestätigen;
- Das Untermenü [8] anwählen und mit der Taste ⏪ bestätigen;
- Der Wert blinkt; den Wert mit den Tasten + und - ändern (0 ... 40°C);
- Die Taste ⏪ drücken, um den eingegebenen Wert zu bestätigen.

4.7 MANUELLE AKTIVIERUNG DES ZUFÜHRSYSTEMS

Bei der ersten Verwendung (Pellettank anfangs leer) oder zum Testen der Funktionsfähigkeit der Zuführeinheit kann das Laden manuell aktiviert werden.

An der Bedientafel des Ofens:



- Mit den Pfeiltasten ◀ ▶ auf das Menü Setup  gehen und die Taste ⏪ drücken;
- Mit der Taste + das Passwort „7“ auswählen und mit der Taste ⏪ bestätigen;
- Mit der Taste + das Untermenü [31] auswählen;
- Mit der Taste + das Passwort „54“ auswählen und mit der Taste ⏪ bestätigen;
- Wird die Taste ⏪ gedrückt gehalten, wird das Zuführsystem aktiviert und auf dem Display werden zunehmende Balken angezeigt;
- Beim Loslassen der Taste wird der Ladevorgang beendet.

Achtung!

- Diese Funktion ist nur aktiviert, wenn der Ofen ausgeschaltet und kalt ist.
- Vor einer erneuten Einschaltung vergewissern, dass sich keine Pellets in der Brennschale befinden.

5 VERWALTUNG DER ALARMMELDUNGEN

Bei Auftreten einer Betriebsstörung wird die folgende Prozedur aktiviert:

1. Akustischer Alarm (Piepton);
2. Eine der folgenden System-LEDs leuchtet auf:   .
3. Wenn die Störung einen Fehler betrifft, wird der Ofen ausgeschaltet

Durch anhaltendes Drücken der Taste „Abbrechen“  wird der Fehlercode auf dem Display angezeigt:

FEHLERCODE MELDUNG	BESCHREIBUNG	MÖGLICHE URSACHEN	LED
E001	Bedienpanel defekt	Defekt des Bedienfelds	
E002	Kommunikationsfehler Fernbedienungs-signal	Defekt des Bedienfelds	
E004	Kommunikationsfehler	Verbindungskabel zwischen Platine und Bedienpanel unterbrochen oder getrennt. Wenn dieser Fehler während des Konfigurationswechsels auftritt, kann er ignoriert werden.	
E101	Fehlgeschlagene Einschaltung Vorlaufwasser zu heiß	Keine Pellets vorhanden Pelletsqualität Einschaltsystem defekt Brenntopf verschmutzt Probleme der Heizungsanlage Probleme der Umwälzpumpe	
E105	Fehlbetrieb des Temperaturfühlers	Wassertemperaturfühler am Rücklauf defekt	
E106	Fehlbetrieb des Temperaturfühlers	Speicherfühler defekt	
E108*	Sicherheitsfehler	Tür oder Füllklappe offen	
E108**	Wärmeschutz	Probleme der Heizungsanlage Probleme der Umwälzpumpe Probleme durch Überhitzung des Pelletbehälters	
E109*	Fehler der Druckführung oder des thermischen Sicherheitssystems	Rauchabzugssystem verschmutzt Dichtungsverschleiß Unzureichende Verbrennungsluft Probleme der Heizanlage Probleme der Umwälzpumpe Überhitzung des Pelletbehälters	
E109**	Fehler wegen Druck	Rauchabzugssystem verschmutzt Dichtungen verschlissen Ungenügende Verbrennungsluft	
E110	Fehlbetrieb des Temperaturfühlers	Wassertemperaturfühler am Vorlauf defekt Lufttemperaturfühler defekt	
E111	Fehlbetrieb des Abgasfühlers	Abgastemperaturfühler defekt	
A001	Niedriger Pelletfüllstand (<i>Symbol blinkt</i>)	Pellets fast leer	
A002	Hinweis auf programmierte Wartung (<i>Symbole blinken</i>)	Der Ofen fordert regelmäßig die Durchführung der Wartung durch einen Fachtechniker an	
A007	Fehlbetrieb des Druckfühlers. (<i>Symbole blinken</i>)	Druckfühler oder Platine defekt.	
----	Ofenreinigung	Brennkammer, Brenntopf oder Rauchabzugssystem verschmutzt. Druckmessrohre getrennt oder verstopft. Verbrennungslufteintritt verstopft.	
----	Fehlgeschlagene Einschaltung	Pellets aufgebraucht; Zündwiderstand defekt; Dichtungen verschlissen; falsche Position des Brenntopfes	

* Lediglich in den Öfen mit Mikro-Sicherheitsschalter auf der Feuerstätte-Tür und auf der Pelletsbehälter-Abdeckung.

** Lediglich in den Öfen ohne Mikro-Sicherheitsschalter auf der Feuerstätte-Tür und auf der Pelletsbehälter -Abdeckung.

Nach Überprüfung der Art der Meldung kann der Alarm zurückgesetzt werden, indem die Ein-/Ausschalttaste einige Sekunden lang gedrückt wird .

Falls der Fehlercode "E108" ist, muss vor Zurücksetzen des Alarms der Thermostat mit manueller Rücksetzung an der Ofenrückseite wieder aktiviert werden (Abb. 11.1). Anschließend kann der Ofen erneut eingeschaltet werden.



Fig.5.1

INDEX

1 PANNEAU DE COMMANDE

- 1.1 DESCRIPTION
- 1.2 UTILISATION DU CLAVIER DE COMMANDE
- 1.3 PARAMÈTRES DE FONCTIONNEMENT

2 OPERATIONS PRELIMINAIRES

- 2.1 REMPLISSAGE DES PELLETS
- 2.2 ALIMENTATION ELECTRIQUE
- 2.3 PARAMÉTRAGES PRÉLIMINAIRES

3 UTILISATION DU POELE

- 3.1 ALLUMAGE
- 3.2 MODIFICATION DES PARAMETRES
- 3.3 EXTINCTION
- 3.4 FONCTIONNEMENT AVEC UN THERMOSTAT AMBIANT
- 3.5 FONCTIONNEMENT AVEC UNE SONDE AMBIANTE INSTALLÉE SUR LE POËLE
- 3.6 FONCTIONNEMENT ASSOCIÉ À UN BALLON D'EAU CHAUDE
- 3.7 FONCTIONNEMENT EN ASSOCIATION AVEC LE SYSTEME "EVERSPRING"

4 FONCTIONS DISPONIBLES

- 4.1 FONCTION TIMER
- 4.2 FONCTION ÉCONOMIE "ECO MODE"
- 4.3 RALLUMAGE APRÈS UNE COUPURE DE COURANT
- 4.4 FONCTION "BLOCAGE CLAVIER"
- 4.5 FONCTION ANTIGEL
- 4.6 FONCTION DELTA DE RALLUMAGE
- 4.7 ACTIVATION MANUELLE DU SYSTEME DE CHARGEMENT

5 GESTION DES ALARMES

1 PANNEAU DE COMMANDE

Avant d'entamer la lecture du manuel, consulter la description du poêle contenue dans le manuel en annexe.

1.1 DESCRIPTION

Composition du clavier de commande:

A) la partie haute avec les LEDS d'état et les icônes rétro éclairées identifiant chaque fonction,

B) un écran à LEDS,

C) une touche d'allumage,

D) une touche "Annuler" et affichage "Alarme",

E) deux touches flèche pour se déplacer dans les différents menus;

F) deux touches  et  pour accéder aux sous-menus et modifier les paramètres de fonctionnement;







G) une touche envoi  pour confirmer le paramètre ou la sélection.









Fig. 1.1

 S'agissant d'un clavier capacitif tactile, il suffit juste d'effleurer les touches pour les activer.

1.1.1 Leds d'état

ICONE	MESSAGE	DESCRIPTION
	Pellets en cours d'épuisement.	Elle signale qu'il faut remplir la trémie de pellets
	Entretien	Elle signale qu'il faut effectuer une opération d'entretien
	Assistance	Elle signale le déclenchement d'une alarme
	Récepteur de la télécommande	EN OPTION
	Timer activé	Elle signale l'activation de la fonction timer.
	Led signalant l'état (près de la touche )	Led allumée: signale que le poêle est en marche Led clignotante: signale que le poêle est en cours d'allumage ou en veille Led éteint: signale que le poêle est éteint

1.1.2 Description des menus

ICON	FUNCTION	DESCRIPTION	VALEURS
	Puissance	Mise au point de la puissance de fonctionnement	1..5
	Ventilation	Réglage de la vitesse du ventilateur de l'air quand le poêle est branché en configuration 5 au système Everspring	1..5; Auto; Hi
	Temperature	Affiche la température lue par la sonde* et permet de programmer la température voulue. *config.1: sonde de l'eau chaude; config.2 - 5: sonde ambiante; config.3-4: sonde externe/ballon d'eau chaude.	config.1: 65..80 °C config.2-5: 10.. 48 °C config.3-4: 45..75 °C
	Fuel	Fonction non utilisée	
	Timer	Active ou désactive la minuterie. Quand la minuterie est activée l'icône  est affichée fixe.	ON - OFF

ICON	FUNCTION	SUBMENU	DESCRIPTION	VALEURS
	Mise au point	[1] Minuterie hebdomadaire	Affectation des programmes (max 3) aux différents jours de la semaine	[d1] ... [d7]
		[2] Programmes	Configuration des programmes	[P1] ... [P6]
		[3] Horloge / date	Réglage de l'horloge et de la date	
		[4] Heures résiduelles	Affiche le nombre d'heures restantes jusqu'au prochain entretien préconisé. La valeur "Hi" indique un nombre supérieur à 999 heures.	
		[5] Informations de système	Affiche la version du logiciel en cours	
		[6] Température de l'eau	Permet de régler la température désirée pour l'eau (uniquement en configuration 2-5).	60 ... 80°C
		[7] Fonction Eco	Active ou désactive le mode Eco qui permet l'arrêt et le rallumage automatique en fonction de la température ambiante (uniquement en configuration 2-5).	OFF; Eco
		[8] Delta de rallumage	ce sont les degrés centigrades sous la température d'extinction au-delà duquel le poêle se rallume automatiquement (Sauf dans les configuration 1).	0,5 ... 5,0°C 0 ... 40°C
		[9] Température hors-gel	Température minimum en dessous de laquelle le poêle s'allume (Sauf dans les configuration 1).	OFF; 3 ... 20°C OFF; 3 ... 50°C
		[10] Verrouillage clavier	Configuration verrouillage des touches	OFF; Lo; Hi
		[11] Luminosité écran	Règle le degré de luminosité de l'écran	OFF; 1 ... 5
		[12] Mode affichage	Configuration de l'affichage des données	OFF; 1 ... 4
		[13] Volume avertisseur sonore	Configuration du volume de l'avertisseur sonore	OFF; 1 ... 5
		[14] Combustion	C'est possible régler trois configurations	1 ... 3
		[30] Menu installateur	Modifie/affiche la configuration du poêle	PWD: "54"
		[31] Chargement manuel de la vis sans fin	Activation manuelle du système de chargement des pellets	PWD: "54"
[33] Alimentation de la pompe	Menu de compétence du centre d'assistance	PWD: "54"		
[34] Activer / Désactiver	Menu di competenza del centro di assistenza	PWD: "54"		
[40] modulation de la pompe	Menu de compétence du centre d'assistance			

Les sous-menus [30] et [40] du menu Configuration sont protégés par un mot de passe et sont à l'usage exclusif du service d'assistance technique.

1.2 UTILISATION DU CLAVIER DE COMMANDE

- L'effleurement des touches flèche ◀ ▶ fait défiler les différents menus qui s'illuminent au fur et à mesure.
- Après avoir sélectionné un menu, les touches + - permettent de faire défiler les sous-menus éventuels; pour modifier un paramètre, il suffit d'effleurer la touche ← et d'en modifier la valeur, toujours avec les touches + -. Effleurer encore une fois la touche ← pour confirmer la modification.
- Généralement tous les paramètres clignotants sont modifiables sur le moment avec les touches + -.
- La touche "Annuler" ⇐ permet de revenir en arrière d'un pas dans les menus. Un effleurement prolongé permet d'afficher le code de l'alarme qui s'est éventuellement déclenchée.

1.3 PARAMÈTRES DE FONCTIONNEMENT

Le fonctionnement du poêle est lié au paramétrage de la puissance et de la température.

1.3.1 Modification de la puissance

La puissance correspond à la quantité de chaleur produite par le poêle, et influe donc directement sur la consommation.

Pour modifier la puissance, sélectionner le menu puissance 🔥 avec les touches ◀ ▶.

- a) Faire défiler le sous-menu avec les touches + -.
- b) Sélectionner le sous-menu "1" et confirmer avec la touche ←.
- c) Le paramètre de la puissance se met à clignoter; le modifier avec les touches + - (1 minimum, ..., 5 maximum).
- d) Effleurer la touche ← pour confirmer la mise au point.

1.3.2 Modification de la température

En fonction de la configuration d'installation du poêle, il est possible de mettre au point différents paramètres de température:

- a) A l'aide des touches ◀ ▶ sélectionner le menu température 🔧 et appuyer sur ←;
- b) Le paramètre en cours se met à clignoter, le modifier avec les touches + -;
- c) Appuyer la touche ← pour confirmer la mise au point.

Température eau (uniquement dans les configurations d'installation 1): la modification de ce paramètre modifie la température souhaitée de refoulement de l'eau chaude par le poêle.

Température ambiante (uniquement dans les configurations d'installation 2 et 5): la modification de ce paramètre définit la température ambiante que l'on souhaite atteindre et qui sera directement lue par la sonde installée sur le poêle.

Température ballon d'eau chaude (uniquement dans les configurations d'installation 3 et 4): c'est la température minimum que l'on souhaite maintenir dans le ballon d'eau chaude.

1.3.3 Modification de la ventilation (uniquement si branchée, en configuration 5, au système Everspring)

Pour modifier la valeur de la ventilation du système Everspring:

- a) A l'aide des touches ◀ ▶ sélectionner le menu ventilation 🌿 et appuyer sur ←;
- b) La valeur de ventilation va clignoter, modifier la valeur par les touches + -;
 - "1" Minimum, ..., "5" maximum;
 - "Auto" = fonctionnement automatique (le poêle mets en place de manière autonome la vitesse du ventilateur et la puissance du poêle par rapport à la température ambiante);
 - "Hi" = Fonctionnement ultrarapide (à utiliser seulement s'il y a la nécessité de réchauffer rapidement une pièce);
- c) Appuyer la touche ← pour confirmer les données choisies.

2 OPERATIONS PRELIMINAIRES

2.1 REMPLISSAGE DES PELLETS

La première opération à effectuer avant d'allumer le poêle est celle de remplir la trémie de pellets.

Les pellets doivent être versés dans la trémie avec une petite pelle.

Ne pas vider directement le sac dans la trémie pour ne pas y jeter de la sciure ou des corps étrangers qui pourraient nuire au bon fonctionnement du poêle, et ne pas verser de pellets en dehors de la trémie.

 Veiller à bien refermer le couvercle de la trémie après avoir chargé les pellets. Un interrupteur de sécurité (uniquement sur les modèles qui le prévoient) en vérifie la fermeture (IS en fig. 2.1)

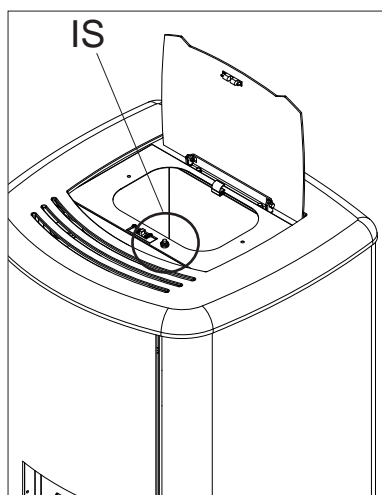

Fig. 2.1

2.2 ALIMENTATION ELECTRIQUE

Brancher le poêle au secteur en plaçant l'interrupteur d'allumage situé au dos du poêle sur "I" (Fig. 2.2). La mise sous tension est signalée par une série de bips par intermittence et par l'allumage de l'écran.

! En prévision d'une longue période d'inactivité, il est conseillé de placer l'interrupteur au dos du poêle sur OFF (O).

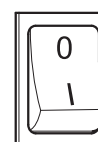



























Fig. 2.2

2.3 PARAMÉTRAGES PRÉLIMINAIRES

Avant d'utiliser le poêle, il faut programmer la date et l'heure en cours.

2.3.1 Paramétrage de l'heure et de la date

Pour modifier la date:

- A l'aide des touches  , sélectionner le menu Configuration  et appuyer sur ;
- Sélectionner le mot de passe "7" avec la touche  et confirmer avec la touche ;
- À l'aide de la touche , sélectionner le sous-menu [3] et confirmer avec la touche ;
- Le paramètre de l'heure se met à clignoter, le modifier avec les touches   puis appuyer la touche ;
- Le paramètre des minutes se met à clignoter, le modifier avec les touches   puis appuyer la touche ;
- Le paramètre du jour se met à clignoter, le modifier avec les touches   puis appuyer la touche ;
- Le paramètre du mois se met à clignoter, le modifier avec les touches   puis appuyer la touche ;
- Le paramètre de l'année se met à clignoter, le modifier avec les touches   puis appuyer la touche ;
- Le paramètre du jour de la semaine en cours (lundi = 1.... dimanche = 7) se met à clignoter, le modifier avec les touches  ;
- Appuyer la touche  pour confirmer la mise au point.

2.3.2 Mise au point de l'affichage

Il est possible de mettre au point les objets que l'on souhaite afficher lorsque l'écran est en veille.

- a) A l'aide des touches ◀ ▶, sélectionner le menu Configuration ⚙ et appuyer sur ⏪;
- b) Sélectionner le mot de passe "7" avec la touche + et confirmer avec la touche ⏪;
- c) À l'aide de la touche +, sélectionner le sous-menu [12] et confirmer avec la touche ⏪;
- d) Mettre au point avec les touches + et - l'un des paramètres suivants:
 - "OFF" • L'afficheur va vous montrer la dernière visualisation réalisée par le client;
 - "1" • Vous allez visualiser cycliquement tous les paramètres;
 - "2" • Vous allez visualiser la température (de la sonde ambiance ou de l'eau selon le type de configuration)
 - "3" • Vous allez visualiser l'heure actuelle
 - "4" • Vous allez visualiser les heures d'autonomie avant de recharger le réservoir d'alimentation, si la fonction "ravitaillement" a été validé.
- e) Appuyer la touche ⏪ pour confirmer la mise au point.

2.3.3 Mise au point de la luminosité de l'écran

Il est possible de mettre au point la luminosité de l'écran lorsqu'il est en mode veille.

- a) A l'aide des touches ◀ ▶, sélectionner le menu Configuration ⚙ et appuyer sur ⏪;
- b) Sélectionner le mot de passe "7" avec la touche + et confirmer avec la touche ⏪;
- c) À l'aide de la touche +, sélectionner le sous-menu [11] et confirmer avec la touche ⏪;
- d) Régler la luminosité souhaitée (OFF, 1 ... 5) à l'aide des touches + et -, puis confirmer avec la touche ⏪.

2.3.4 Mise au point du volume de l'avertisseur sonore

Il est possible de mettre au point le volume de l'avertisseur sonore en fonction de ses exigences.

- a) A l'aide des touches ◀ ▶, sélectionner le menu Configuration ⚙ et appuyer sur ⏪;
- b) Sélectionner le mot de passe "7" avec la touche + et confirmer avec la touche ⏪;
- c) À l'aide de la touche +, sélectionner le sous-menu [13] et confirmer avec la touche ⏪;
- d) Régler le volume souhaité (OFF, 1 ... 5) à l'aide des touches + et -, puis confirmer avec la touche ⏪.

2.3.5 Optimisation de la combustion

Une combustion optimale est liée à différents facteurs (type d'installation, conditions de fonctionnement et d'entretien, qualité du combustible etc..)

En ligne général, si à la fin de la combustion, dans le brasero il y a pas mal de résidus, il vaut mieux modifier les configurations du combustible (en augmentant sa valeur) jusqu'à trouver la meilleure solution possible.

- a) A l'aide des touches ◀ ▶, sélectionner le menu Configuration ⚙ et appuyer sur ⏪;
- b) Sélectionner le mot de passe "7" avec la touche + et confirmer avec la touche ⏪;
- c) À l'aide de la touche +, sélectionner le sous-menu [14] et confirmer avec la touche ⏪;
- d) Mettre au point avec les touches + et - l'un des paramètres suivants:
 - "1"
 - "2"
 - "3"
- e) Appuyer la touche ⏪ pour confirmer la mise au point.

3 UTILISATION DU POËLE

3.1 ALLUMAGE

Avant chaque allumage, assurez-vous que le brasero est vide et correctement positionné dans son logement.

Pour allumer le poêle, appuyer sur la touche  pendant quelques secondes.

L'icône de la flamme se met à clignoter pendant la phase d'allumage, puis reste allumée fixement pour signaler l'allumage du poêle.

! Allumage automatique: le poêle est équipé d'un dispositif automatique permettant d'allumer les pellets sans recourir aux allume-feux traditionnels.

 Ne pas allumer manuellement le poêle si le dispositif d'allumage automatique est défectueux.

! Lors du premier allumage du poêle, de mauvaises odeurs peuvent se dégager provoquées par l'évaporation ou le séchage de certains matériaux de construction. Ces odeurs disparaîtront au fur et à mesure.

Il est conseillé de bien ventiler les pièces lors des premiers allumages.

3.2 MODIFICATION DES PARAMETRES

Il est possible modifier les paramètres de fonctionnement du poêle comme indiqué.

Les paramètres demeurent inchangés tant qu'ils n'auront pas été modifiés, y compris après l'extinction du poêle ou son débranchement.

3.3 EXTINCTION

Pour éteindre le poêle, effleurer la touche  pendant quelques secondes ; l'icône de la flamme s'éteindra.

Pour rallumer le poêle, il est conseillé d'attendre son refroidissement complet.

 Il est conseillé d'éteindre le poêle en suivant scrupuleusement les indications ci-dessus et jamais en coupant l'arrivée de l'alimentation électrique.

3.4 FONCTIONNEMENT AVEC UN THERMOSTAT AMBIANT

En cas de contrôle du poêle avec un thermostat (ou chrono-thermostat) extérieur, l'installateur doit programmer la configuration 1.

Dans cette configuration, le poêle s'éteint lorsque le thermostat extérieur se déclenche (circuit ouvert) ou module son fonctionnement (le poêle maintient la température mise au point en consommant le moins possible) lorsque la température programmée de l'eau est atteinte.

Le poêle se rallume automatiquement lorsque la température descend sous la valeur mise au point

sur le thermostat extérieur (circuit fermé).



Au premier allumage ou si le poêle a été éteint depuis le clavier de commande (touch ) , le rallumage doit s'effectuer depuis le clavier de commande.



Le poêle s'arrêtera aussi si la température continue à augmenter malgré la modulation. Dans ce cas le poêle va se mettre en marche seulement si la différence entre la valeur de la température choisie et la température real est supérieur à 20°C.

Nous vous conseillons donc, dans ce type de configuration, de régler la température de l'eau sur une valeur haute (ex. 70°C).

3.5 FONCTIONNEMENT AVEC UNE SONDE AMBIANTE INSTALLÉE SUR LE POËLE

Le poêle peut être allumé/éteint manuellement ou de façon programmée.

Dans ce type de configuration, le poêle module sa puissance en fonction de la température ambiante lue par la sonde à bord (le poêle maintient la température mise au point en consommant le moins possible).

Si la fonction "Eco-mode" a été activée dans le sous-menu [7] du menu Configuration  , au lieu de moduler sa puissance, le poêle s'éteint lorsque la température programmée a été atteinte, et se rallume lorsque la température ambiante descend sous le delta défini dans le sous-menu [7] du menu Configuration .



Il est possible de mettre au point la température ambiante souhaitée dans le menu température .

Le sous-menu [6] du menu Configuration  permet de programmer la température de l'eau de refoulement (se renseigner auprès de son installateur pour connaître la température la mieux adaptée à son installation de chauffage).

3.6 FONCTIONNEMENT ASSOCIÉ À UN BALLON D'EAU CHAUDE

Pour un fonctionnement associé à un ballon d'eau chaude, l'installateur programmera la configuration 3 ou 4 selon qu'il s'agisse d'un ballon d'eau chaude avec ou sans serpentin interne.

Le poêle est contrôlé par la température lue par la sonde dans le ballon d'eau chaude..

Lorsque l'eau dans le ballon atteint la température programmée dans le menu température  le poêle s'éteint et se rallume si la température descend sous le delta défini dans le sous-menu [8] du menu Configuration .

Dans cette configuration, il est aussi possible de mettre au point la fonction antigel.

3.7 FONCTIONNEMENT EN ASSOCIATION AVEC LE SYSTEME "EVERSPRING"



Avant d'utiliser le produit en association avec le système "Everspring", s'assurer d'avoir lu toute la documentation fournie avec l'installation et d'avoir reçu les instructions appropriées par l'installateur sur le fonctionnement de l'installation et de l'éventuelle unité de rafraîchissement.

Quand le poêle est branché au système Everspring, il doit être réglé en configuration 5.







Dans cette configuration, il peut être allumé/éteint manuellement ou en mode programmé.

Le poêle peut fonctionner en mode hivernal (par défaut) ou en mode estival, si le système Everspring prévoit également une unité de rafraîchissement.

Par l'intermédiaire du menu de la ventilation , l'utilisateur peut modifier la vitesse de l'air chaud/froid à travers l'unité Everspring.

3.7.1 En fonctionnement Hivernal

Pour passer du fonctionnement estival au fonctionnement hivernal, avec le poêle éteint (froid) mais alimenté :

- A l'aide des touches   se positionner sur le menu puissance  et appuyer sur la touche  ;
- La valeur "SUN" clignotera : la modifier à l'aide de la touche  jusqu'à l'obtention d'une valeur comprise entre 1 et 5 ;
- Appuyer sur la touche  pour confirmer la sélection.

Dans ce type de configuration, la chaudière module la puissance en fonction de la température ambiante lue par la sonde à bord du système Everspring (c'est-à-dire que la chaudière tente de maintenir la température souhaitée en consommant le moins possible).







Si l'utilisateur a activé la fonction "Eco-mode" dans le sous-menu [7] du menu setup , la chaudière, au lieu de moduler, s'éteint une fois la température définie atteinte, et se rallume quand la température ambiante descend en dessous du delta indiqué dans le sous-menu [8] dans le menu setup .

Il est possible de définir la température souhaitée dans le menu température .

Dans le sous-menu [6] du menu setup , il est possible de définir la température souhaitée de l'eau de refoulement (il est conseillé de définir cette température à environ 70°C).



3.7.2 Fonctionnement Estival (à utiliser s'il existe une unité de rafraîchissement associée à Everspring)

Pour passer du fonctionnement estival, avec le poêle éteint (froid) mais alimenté :

- A l'aide des touches   se positionner sur le menu puissance  et appuyer sur la touche  ;
- La valeur actuelle clignotera ; la modifier à l'aide de la touche  jusqu'à la valeur "SUN" ;
- Appuyer sur la touche  pour confirmer la sélection.



Régler la température estivale souhaitée dans le menu température .

Dans cette modalité, le poêle active l'unité de rafraîchissement quand la température ambiante dépasse la température définie dans le menu température  et éteint l'unité quand la température ambiante descend en dessous du delta indiqué dans le sous-menu [8]] du menu setup .



Après avoir réglé le fonctionnement estival, pour en activer le fonctionnement il faut appuyer sur la touche d'allumage  sur le panneau de commande.

4 FONCTIONS DISPONIBLES

4.1 FONCTION TIMER

Cette fonction permet de programmer et d'assigner aux différents jours de la semaine des programmes personnalisés permettant d'allumer et/ou d'éteindre automatiquement le poêle.

Il est possible de mettre au point jusqu'à six programmes personnalisés.

Dans chaque programme on peut mettre au point l'heure d'allumage et d'extinction ainsi que la température souhaitée.

Il est possible d'assigner jusqu'à 3 programmes pour chaque jour de la semaine.

Les jours de la semaine sont identifiés par un chiffre allant de 1 à 7 : lundi = "d1", mardi = "d2" ;... ; dimanche = "d7".

4.1.1 Mise au point des programmes

- A l'aide des touches ◀ ▶, sélectionner le menu Configuration ⚙ et appuyer sur ⏪;
- Sélectionner le mot de passe "7" avec la touche + et confirmer avec la touche ⏪;
- Sélectionner le sous-menu [2] et confirmer avec la touche ⏪;
- A l'aide des touches + - faire défiler les programmes P1...P6 ; à l'aide de la touche ⏪ sélectionner celui que l'on souhaite modifier.
- Le paramètre de l'heure d'allumage se met à clignoter; modifier le paramètre avec les touches + - puis appuyer la touche ▶
- Le paramètre des minutes se met à clignoter; modifier le paramètre avec les touches + - puis appuyer la touche ▶
- Le paramètre de l'heure d'extinction se met à clignoter; modifier le paramètre avec les touches + - puis appuyer la touche ▶
- Le paramètre des minutes se met à clignoter; modifier le paramètre avec les touches + - puis appuyer la touche ▶
- Le paramètre de la température souhaitée se met à clignoter; modifier le paramètre avec les touches + - puis appuyer la touche ▶
- Appuyer la touche ⏪ pour confirmer la mise au point.

4.1.2 Assignation des programmes aux jours de la semaine

Cette fonction permet d'assigner jusqu'à 3 programmes différents à un jour déterminé.

- A l'aide des touches ◀ ▶, sélectionner le menu Configuration ⚙ et appuyer sur ⏪;
- Sélectionner le mot de passe "7" avec la touche + et confirmer avec la touche ⏪;
- Sélectionner le sous-menu [1] et confirmer avec la touche ⏪;
- Sélectionner avec les touches + - le jour [d1]...[d7] auquel on souhaite associer les programmes;
- Le sélectionner avec la touche ⏪;
- Le paramètre du premier programme à assigner se met à clignoter: P1...P6 ou "OFF" pour le désactiver;
- Modifier le paramètre avec les touches + - puis appuyer la touche ▶;
- Le paramètre du deuxième programme à assigner se met à clignoter: P1...P6 ou "OFF" pour le désactiver;
- Modifier le paramètre avec les touches + - puis appuyer la touche ▶;
- Le paramètre du troisième programme à assigner se met à clignoter: P1...P6 ou "OFF" pour le désactiver;
- Modifier le paramètre avec les touches + - puis appuyer la touche ⏪ pour confirmer la mise au point.

4.1.3 Activation / désactivation du timer

- A l'aide des touches flèche ◀ ▶ sélectionner le menu Timer ⌚.
- Confirmer avec la touche ⏪;
- A l'aide des touches + - faire défiler et sélectionner: "ON" pour activer le timer ou "OFF" pour le désactiver.
- Appuyer la touche ⏪ pour confirmer la sélection.

Quand la minuterie est activée l'icône fixe ⌚ s'affiche .

4.2 FONCTION ÉCONOMIE “ECO MODE”

Cette fonction éteint le poêle lorsque la température ambiante programmée est atteinte. Si cette fonction n'est pas activée, le poêle module son fonctionnement pour maintenir la température programmée en consommant le moins possible. La fonction “Eco Mode” n'est disponible que dans la configuration 2.

Pour activer/désactiver cette fonction:

- A l'aide des touches ◀ ▶, sélectionner le menu Configuration ⚙ et appuyer sur ⏪;
- Sélectionner le mot de passe “7” avec la touche + et confirmer avec la touche ⏪;
- Sélectionner le sous-menu [7] et confirmer avec la touche ⏪.
- Mettre au point avec les touches + - l'un des paramètres suivants:
Eco → Validation de la fonction “Eco Mode”
Off → Désactivation de la fonction “Eco Mode”
- Appuyer la touche ⏪ pour confirmer la mise au point.

4.3 RALLUMAGE APRÈS UNE COUPURE DE COURANT

Après une interruption de courant, le poêle se rallume automatiquement et effectue un autodiagnostic au retour de l'alimentation.

4.4 FONCTION “BLOCAGE CLAVIER”

Cette fonction permet de bloquer le clavier de commande afin de prévenir toute modification intempestive.

Pour activer/désactiver cette fonction:

- A l'aide des touches ◀ ▶, sélectionner le menu Configuration ⚙ et appuyer sur ⏪;
- Sélectionner le mot de passe “7” avec la touche + et confirmer avec la touche ⏪;
- Sélectionner le sous-menu [10] et confirmer avec la touche ⏪;
- à l'aide des touches + - mettre au point l'un des paramètres suivants:
“Off” Verrouillage clavier désactivé
“Lo” seule la touche allumage/extinction ⏻ est activée
“Hi” Verrouillage clavier activé
- Appuyer la touche ⏪ pour confirmer la mise au point.

4.5 FONCTION ANTIGEL

Les configurations d'installation 2, 3 et 4 permettent de mettre au point une température minimum en dessous de laquelle le poêle s'allume (en-dehors des tranches horaires programmées).

Configuration 2:

Pour modifier le paramètre de la température “antigel”:

- A l'aide des touches ◀ ▶, sélectionner le menu Configuration ⚙ et appuyer sur ⏪;
- Sélectionner le mot de passe “7” avec la touche + et confirmer avec la touche ⏪;
- Sélectionner le sous-menu [9] et confirmer avec la touche ⏪;
- Le paramètre se met à clignoter, le modifier avec les touches + - (OFF; 3...20°C);
- Appuyer la touche ⏪ pour confirmer la mise au point.

Configuration 3 e 4:

Pour modifier le paramètre de la température “antigel”:

- A l'aide des touches ◀ ▶, sélectionner le menu Configuration ⚙ et appuyer sur ⏪;
- Sélectionner le mot de passe “7” avec la touche + et confirmer avec la touche ⏪;
- Sélectionner le sous-menu [9] et confirmer avec la touche ⏪;
- Le paramètre se met à clignoter, le modifier avec les touches + - (OFF; 3...50°C);
- Appuyer la touche ⏪ pour confirmer la mise au point.

En entrant “OFF” à l'étape d, cette fonction sera désactivée.

4.6 FONCTION DELTA DE RALLUMAGE

Delta de rallumage: (dans les configurations d'installation 2, 3, 4 et 5): ce sont les degrés centigrades sous la température d'extinction au-delà duquel le poêle se rallume automatiquement. Par exemple, si le poêle est programmé pour s'éteindre à 20°C (Eco Mode activé) et le "Delta de rallumage" a été défini à 4°C, le poêle se rallumera lorsqu'il aura relevé une température inférieure ou égale à 16°C.

Configuration 2 et 5:

Pour modifier la valeur du delta de rallumage:

- A l'aide des touches ◀ ▶, sélectionner le menu Configuration ⚙ et appuyer sur ⏪;
- Sélectionner le mot de passe "7" avec la touche + et confirmer avec la touche ⏪;
- Sélectionner le sous-menu [8] et confirmer avec la touche ⏪;
- Le paramètre se met à clignoter, le modifier avec les touches + et - (0,5 ... 5,0°C);
- Appuyer sur la touche ⏪ pour confirmer.

Configuration 3 et 4:

Pour modifier la valeur du delta de rallumage:

- A l'aide des touches ◀ ▶, sélectionner le menu Configuration ⚙ et appuyer sur ⏪;
- Sélectionner le mot de passe "7" avec la touche + et confirmer avec la touche ⏪;
- Sélectionner le sous-menu [8] et confirmer avec la touche ⏪;
- Le paramètre se met à clignoter, le modifier avec les touches + et - (0 ... 40°C);
- Appuyer sur la touche ⏪ pour confirmer.

4.7 ACTIVATION MANUELLE DU SYSTEME DE CHARGEMENT

En cas de première utilisation (réservoir à pellets initialement vide), ou pour tester le fonctionnement du groupe de chargement, il est possible d'actionner manuellement le chargement.

Sur le panneau de commande du poêle:



- En agissant sur les touches flèche ◀ ▶, se placer sur le menu setup ⚙ et appuyer sur la touche ⏪;
- Sélectionner le mot de passe "7" à l'aide de la touche + et confirmer à l'aide de la touche ⏪;
- Parcourir à l'aide de la touche + et sélectionner le sous-menu [31];
- Sélectionner le mot de passe "54" à l'aide de la touche + et confirmer à l'aide de la touche ⏪;
- En maintenant la touche ⏪ enfoncée, le système de chargement s'activera et l'afficheur visualisera des barres "réseau".
- En relâchant la touche, l'opération de chargement se terminera.

Attention !

- Cette fonction est active uniquement si le poêle est éteint et froid.
- Avant un nouvel allumage, s'assurer qu'il n'y ait pas de pellets dans le four.

5 GESTION DES ALARMES

Un dysfonctionnement est signalé par la procédure suivante:

1. avertissement sonore (bip);
2. allumage de l'une des icônes suivantes:   ;
3. s'il s'agit d'une alarme, le poêle s'éteint.

L'effleurement prolongé de la touche "annuler"  affiche le code de l'alarme:

CODE ALARME / MESSAGE	DESCRIPTION	CAUSES PROBABLES	LED
E001	Clavier de commande défectueux	Défaut du clavier de commande	
E002	Non réception du signal de la télécommande	Défaut du clavier de commande	
E004	Coupure de liaison	Coupure ou débranchement du câble reliant la carte au clavier de commande. Ignorer cette alarme, si elle s'affiche pendant le changement de configuration.	
E101	Allumage raté. Eau de refolement trop chaude.	Absence de pellets Qualité du pellet Défaut du système d'allumage Brasero sale Problèmes sur l'installation de chauffage Problèmes sur le circulateur	
E105	Dysfonctionnement sonde de température	Sonde eau de retour défectueuse	
E106	Dysfonctionnement sonde de température	Sonde puffer défectueuse	
E108*	Erreur de sécurité	Porte ou volet de chargement ouverts	
E108**	Déclenchement du disjoncteur	Problèmes sur l'installation de chauffage Problèmes sur le circulateur Surchauffe de la trémie de pellets	
E109*	Erreur de pression ou sécurité thermique	Système d'évacuation des fumées sales Joints d'étanchéité endommagés Air comburant insuffisant Problèmes sur l'installation de chauffage Problèmes sur le circulateur Problèmes de surchauffe du réservoir à pellets	
E109**	Alarme de pression	Système d'évacuation de la fumée sale Usure des joints d'étanchéité Air comburant insuffisant	
E110	Dysfonctionnement sonde de température	Sonde eau de refolement défectueuse Sonde air défectueuse	
E111	Dysfonctionnement sonde fumée	Sonde température fumée défectueuse	
A001	Niveau pellets insuffisant (<i>icône clignotante</i>)	Pellets en cours d'épuisement	
A002	Avertissement entretien programmé (<i>icônes clignotantes</i>)	Le poêle requiert un entretien régulier à effectuer par un personnel spécialisé.	 
A007	Dysfonctionnement capteur de pression (<i>icône clignotante</i>)	Défaut du capteur de pression ou de la carte	
----	Nettoyage du poêle	Chambre de combustion, braséro ou système d'évacuation de la fumée sales. Encrassement ou décrochement des tuyaux de relevé de la pression. Encrassement de l'arrivée de l'air comburant.	
----	Allumage raté	Absence de pellets; Défaut de la résistance d'allumage; Joints usés; Mauvais positionnement du braséro.	

* Seulement dans les poêles équipés de micro interrupteurs de sécurité sur la porte du foyer et sur le couvercle du réservoir.

** Seulement dans les poêles sans micro interrupteurs de sécurité sur la porte du foyer et sur le couvercle du réservoir.

Après avoir vérifié le message, l'alarme peut être effacée en effleurant pendant quelques secondes la touche d'allumage/extinction .

En cas d'affichage du code "E108 ou E109", avant d'effacer l'alarme, réenclencher manuellement le thermostat situé au dos du poêle (Fig. 11.1). On peut à présent rallumer le poêle.



Fig.5.1

ÍNDICE

1 PANEL DE MANDOS

- 1.1 DESCRIPCIÓN
- 1.2 USO DEL PANEL DE MANDO
- 1.3 PARÁMETROS DE FUNCIONAMIENTO

2 OPERACIONES PRELIMINARES

- 2.1 CARGA DE LOS PELLETS
- 2.2 ALIMENTACIÓN ELÉCTRICA
- 2.3 PROGRAMACIONES INICIALES

3 USO DE LA ESTUFA

- 3.1 ENCENDIDO
- 3.2 MODIFICACIÓN DE LOS PARÁMETROS
- 3.3 APAGADO
- 3.4 FUNCIONAMIENTO CON TERMOSTATO AMBIENTE
- 3.5 FUNCIONAMIENTO CON Sonda AMBIENTE A BORDO CALDERA
- 3.6 FUNCIONAMIENTO EN COMBINACIÓN CON UN DEPÓSITO
- 3.7 FUNCIONAMIENTO EN COMBINACIÓN AL SISTEMA "EVERSPRING"

4 FUNCIONES DISPONIBLES

- 4.1 FUNCIÓN TEMPORIZADOR
- 4.2 FUNCIÓN AHORRO "ECO MODE"
- 4.3 REENCENDIDO DESPUÉS DEL BLACK-OUT
- 4.4 FUNCIÓN "BLOQUEO BOTONERA"
- 4.5 FUNCIÓN ANTICONGELACIÓN
- 4.6 FUNCIÓN DELTA DE REENCENDIDO
- 4.7 ACTIVACIÓN MANUAL DEL SISTEMA DE CARGA

5 GESTIÓN DE LAS ALARMAS

1 PANEL DE MANDOS

Antes de leer este manual, consultar la descripción de la estufa en el manual adjunto.

1.1 DESCRIPCIÓN

El panel de mando se compone de:

A) una parte superior con los led de estado y los iconos con iluminación posterior que identifican cada función;

B) visor de led;

C) botón de encendido;

D) botón "Anular" y visualización "error";

E) dos botones flecha para desplazarse por las diferentes funciones;

F) dos botones (+) y (-) para entrar a los submenú y modificar los parámetros de funcionamiento;

G) un tasto de envío (↵) para confirmar el parámetro o su selección.

 Todos los botones son de tipo capacitivo por lo tanto no necesitan ser presionados para su activación, es suficiente tocar la superficie.

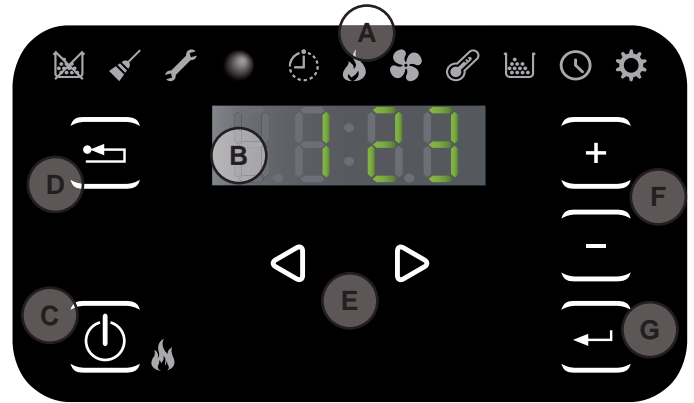















Fig. 1.1

1.1.1 Led de estado

ICONO	AVISO	DESCRIPCIÓN
	Pellet acabándose	Indica que es necesario recargar el depósito de pellet.
	Mantenimiento	Indica que es necesario realizar un mantenimiento
	Asistencia	Indica la presencia de error
	Receptor del mando a distancia	OPCIONAL
	Temporizador activo	Indica si está activa la función temporizador
	Led de señalización estado (cerca del botón )	Led siempre encendido: estufa encendida y en funcionamiento Led intermitente: Estufa en fase de encendido o en stand-by Led apagado: Estufa apagada











1.1.2 Descripción de los menús

ICONO	FUNCIÓN	DESCRIPCIÓN	VALORES
	Potencia	Programación de la potencia de funcionamiento	1..5
	Ventilación	Configuración de la velocidad del ventilador del aire cuando la estufa está conectada en configuración 5 al sistema Everspring	1..5; Auto; Hi
	Temperature	Muestra la temperatura leída por la sonda* y permite programar la temperatura deseada. *config.1: sonda agua caliente; config.2-5: sonda ambiente; config. 3-4: sonda externa/depósito.	config.1: 65..80 °C config.2-5: 10.. 48 °C config.3-4: 45..75 °C
	Fuel	Función no utilizada	
	Timer	Habilita o deshabilita el Temporizador. Cuando está habilitado muestra el icono fijo 	ON - OFF

ICONO	FUNCIÓN	SUBMENU	DESCRIPCIÓN	VALORES
	Setup	[1] Temporizador semanal	Asignación de los programas (máx. 3) a los diferentes días de la semana	[d1] ... [d7]
		[2] Programas	Menú de configuración de los programas	[P1] ... [P6]
		[3] Reloj /fecha	Programación reloj y fecha	
		[4] Horas Restantes	Visualiza las horas faltantes aconsejadas para el mantenimiento. Con el valor "Hi" se indica un número de horas superior a 999.	
		[5] Informaciones del sistema	Visualiza la versión software actual	
		[6] Temperatura agua	Permite ajustar la temperatura deseada para el agua (sólo en la configuración 2 - 5).	60 ... 80°C
		[7] Función Eco	Habilita o no el Modo Eco que implica el apagado y reencendido automático en función de la temperatura ambiente (sólo en la configuración 2 - 5).	OFF; Eco
		[8] Delta de reencendido	Es el número de grados centígrados por debajo de la temperatura de apagado superado el cual la estufa se reenciende automáticamente (excepto en la configuración 1).	0,5 ... 5,0°C 0 ... 40°C
		[9] Temperatura anticongelación	Temperatura mínima por debajo de la cual la estufa se enciende (excepto en la configuración 1).	OFF; 3 ... 20°C OFF; 3 ... 50°C
		[10] Bloqueo botonera	Programa el modo de bloqueo de los datos	OFF; Lo; Hi
		[11] Luminosidad del visor	Programa el grado de luminosidad del visor	OFF; 1 ... 5
		[12] Modo visor	Programa el modo de visualización de los datos	OFF; 1 ... 4
		[13] Volumen timbre eléctrico	Programa el volumen del aviso acústico	OFF; 1 ... 5
		[14] Combustión	Puede establecer tres configuraciones diferentes de combustión	1 ... 3
		[30] Menú instalador	Modifica/visualiza la configuración de la estufa	PWD: "54"
		[31] Carga cóclea manual	Activación manual del sistema de carga del pellet	PWD: "54"
[33] Alimentación bomba	Menú de competencia del centro de asistencia	PWD: "54"		
[34] Encendido / Apagado	Menu di competenza del centro di assistenza	PWD: "54"		
[40] modulación bomba	Menú de competencia del centro de asistencia			

Los submenús [30] y [40] del menú Setup están protegidos con una contraseña y son de uso exclusivo del centro de asistencia técnico.

1.2 USO DEL PANEL DE MANDO



- Usando las flechas   se desplaza entre los diferentes menús que se iluminan cada vez.
- Deteniéndose en una determinada función se pueden pasar los posibles submenú con los botones  ; para modificar un parámetro es suficiente usar el botón  y cambiar los valores, siempre con los botones  . Otra presión del botón  confirma la modificación.
- En general todos los valores que parpadean en ese momento se pueden modificar con los botones  .
- El botón “anular”  permite volver atrás un nivel en los menús, su presión prolongada permite la visualización en el visor de un posible código de alarma o de error.







1.3 PARÁMETROS DE FUNCIONAMIENTO

El funcionamiento de la estufa depende de los parámetros de Potencia y Temperatura programados por el usuario.

1.3.1 MODIFICACIÓN DE LA POTENCIA







La potencia define la cantidad de calor producida por la estufa y por lo tanto incide directamente también en los consumos.

Para modificar la potencia ir con los botones   al menú potencia .

- a) Pasar con los botones   el submenú.
- b) Seleccionar el submenú “1” y confirmar con el botón .
- c) Parpadeará el valor de potencia, modificar el valor con los botones   (1 mínimo,...,5 máximo).
- d) Presionar el botón  para confirmar los datos programados.

1.3.2 Modificación de la temperatura

En función de la configuración instalada en la caldera es posible cambiar los diferentes valores de temperatura:

- a) Usando los botones   ir al menú temperatura  y pulsar el botón .
- b) Parpadeará el valor actual, modificarlo con los botones  .
- c) Presionar el botón  para confirmar el dato programado.







Temperatura agua (sólo en las configuraciones de instalación 1): cambiando este valor se cambia la temperatura deseada de entrada del agua caliente por parte de la caldera.

Temperatura ambiente (sólo en las configuraciones de instalación 2 y 5): modificando dicho valor se define la temperatura que se desea alcanzar en el ambiente, leída directamente por una sonda situada en la caldera.

Temperatura depósito (sólo en las configuraciones de instalación 3 y 4): identifica la temperatura mínima que se desea mantener dentro del depósito.

1.3.3 Modificación de la ventilación (sólo si está conectada, en configuración 5, al sistema Everspring)

Para modificar el valor de la ventilación del sistema Everspring:

- a) Usando los botones   ir al menú ventilación  y pulsar el botón .
- b) Cuando el valor de ventilación parpadeará, modificar el valor con los botones  ;
 - “1” mínima ,..., “5” máxima;
 - “Auto” = funcionamiento automático (la estufa seleccionará en modo autónomo la velocidad del ventilador y la potencia de la estufa en base a la temperatura del ambiente);
 - “Hi” = funcionamiento ultra rápido (el cual utilizar solo si hay necesidad de rescaldar rápidamente un ambiente);
- c) Pinchar el botón  para confirmar los datos modificados.

2 OPERACIONES PRELIMINARES

2.1 CARGA DE LOS PELLETS

La primera operación a realizar antes de encender el producto es llenar el depósito de combustible (pellet).

El pellet debe introducirse en el depósito con una paleta.

No vaciar la bolsa directamente en el depósito para evitar descargar aserrín u otros elementos extraños que podrían afectar el buen funcionamiento de la estufa y para evitar que se esparzan pellets fuera del depósito.



Asegurarse que se ha cerrado bien la tapa del depósito después que se realiza la operación de carga de pellets.

Un interruptor de seguridad (sólo para los modelos donde esté previsto) comprueba el cierre correcto (IS en la fig. 2.1).

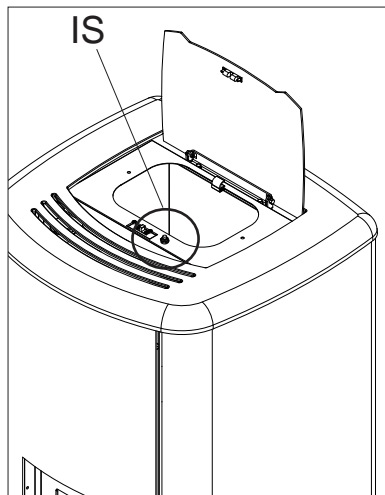

Fig. 2.1

2.2 ALIMENTACIÓN ELÉCTRICA

Conectar la estufa a la red eléctrica, usar el interruptor de encendido colocado en la parte posterior de la estufa posicionándolo en "1" (Fig. 2.2). Si la conexión es correcta, la estufa emitirá una serie de señales acústicas intermitentes, y se enciende el visor.



Para períodos prolongados de desuso, se aconseja posicionar el interruptor posterior de la máquina en la posición OFF (0).

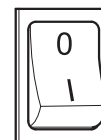

Fig. 2.2

2.3 PROGRAMACIONES INICIALES

Antes de utilizar la estufa es necesario programar la fecha y la hora corriente.

2.3.1 Programación horario

Para modificar la fecha:

- Usando los botones ir al menú setup y pulsar el botón ;
- Seleccionar la contraseña "7" con el botón y confirmar con el botón ;
- Pasar con el botón , seleccionar el submenú [3] y confirmar con el botón ;
- Parpadeará el valor de la hora, modificar el valor con los botones y presionar el botón ;
- Parpadeará el valor de los minutos, modificar el valor con los botones y presionar el botón ;
- Parpadeará el valor del día, modificar el valor con los botones y presionar el botón ;
- Parpadeará el valor del mes, modificar el valor con los botones y presionar el botón ;
- Parpadeará el valor del año, modificar el valor con los botones y presionar el botón ;
- Parpadeará el valor del día corriente de la semana (Lunes = 1... Domingo = 7) modificar el valor con los botones ;
- Presionar el botón para confirmar los datos programados.

2.3.2 Programaciones modo visor

Es posible programar lo que se querrá visualizar en el visor cuando éste esté en el modo standby.

- a) Usando los botones ◀ ▶ ir al menú setup ⚙️ y pulsar el botón ⏪;
- b) Seleccionar la contraseña "7" con el botón + y confirmar con el botón ⏪;
- c) Pasar con el botón +, seleccionar el submenú [12] y confirmar con el botón ⏪;
- d) Programar con los botones + y - uno de los siguientes valores:
 - "OFF" • El panel muestra la última visualización efectuada por el usuario;
 - "1" • Se visualizan de manera cíclica todos los parametros de funcionamiento;
 - "2" • Se visualiza la temperatura (de la sonda ambiente o del agua en función del tipo de configuración)
 - "3" • Se visualiza la hora actual.
 - "4" • Se visualizan las horas de autonomía que faltan antes de recargar el depósito de alimentación, Si la función "abastecimiento" a sido activada.
- e) Presionar el botón ⏪ para confirmar los datos programados.

2.3.3 Programación luminosidad visor

Se puede programar el grado de atenuación de la luminosidad del visor cuando está en el modo standby.

- a) Usando los botones ◀ ▶ ir al menú setup ⚙️ y pulsar el botón ⏪;
- b) Seleccionar la contraseña "7" con el botón + y confirmar con el botón ⏪;
- c) Pasar con el botón +, seleccionar el submenú [11] y confirmar con el botón ⏪;
- d) Programar con los botones + y - el valor de luminosidad deseado (OFF,1 ... 5) y confirmar con el botón ⏪.

2.3.4 Programación del volumen

Es posible programar el nivel de volumen del timbre eléctrico en función de las propias necesidades:

- a) Usando los botones ◀ ▶ ir al menú setup ⚙️ y pulsar el botón ⏪;
- b) Seleccionar la contraseña "7" con el botón + y confirmar con el botón ⏪;
- c) Pasar con el botón +, seleccionar el submenú [13] y confirmar con el botón ⏪;
- d) Programar con los botones + y - el nivel de volumen deseado (OFF,1 ... 5) y confirmar con el botón ⏪.

2.3.5 Optimización de la combustión

Una combustión óptima depende de varios factores (tipo de condiciones de instalación, operación y mantenimiento, tipo de pellet etc ..)

Si al final de la combustión en el brasero son muchos residuos, es aconsejable cambiar las configuraciones de combustión (aumentando el valor) para encontrar la solución más satisfactoria.

- a) Usando los botones ◀ ▶ ir al menú setup ⚙️ y pulsar el botón ⏪;
- b) Seleccionar la contraseña "7" con el botón + y confirmar con el botón ⏪;
- c) Pasar con el botón +, seleccionar el submenú [14] y confirmar con el botón ⏪;
- d) Seleccionar el submenú "2" y confirmar con el botón + y - uno de los siguientes valores:
 - "1"
 - "2"
 - "3"
- e) Presionar el botón ⏪ para confirmar los datos programados.

3 USO DE LA ESTUFA

3.1 ENCENDIDO

 Antes de cada puesta en marcha, asegúrese de que el brasero esté completamente vacío y colocado correctamente en su asiento.

Para encender la estufa mantener presionado el botón  durante algunos segundos.

El icono en forma de llama comenzará a parpadear, durante la fase de encendido hasta quedar fija con la estufa encendida.

 Encendido automático: La estufa está dotada de un dispositivo automático que permite el encendido del pellet sin recurrir al uso de otros encendedores tradicionales.

 Evitar encender manualmente la estufa si el sistema de encendido automático está afectado.

 En el primer encendido de la estufa, se pueden generar desagradables olores o humos debidos a la evaporación o el desecado de algunos materiales utilizados. Este fenómeno desaparecerá gradualmente.

En los primeros encendidos se aconseja mantener los locales bien aireados.

3.2 MODIFICACIÓN DE LOS PARÁMETROS

Es posible modificar los parámetros de funcionamiento de la estufa según lo indicado.

 Los valores programados serán mantenidos hasta la siguiente variación, incluso si la estufa está apagada o desconectada de la alimentación eléctrica.

3.3 APAGADO

Para apagar la estufa tener presionado el botón  durante algunos segundos, el icono con forma de llama se apagará.

 Para realizar un nuevo encendido se aconseja esperar que la estufa esté completamente encendida.

 Se recomienda apagar la estufa siguiendo escrupulosamente cuanto arriba indicado para evitar hacerlo desconectando la alimentación eléctrica.



3.4 FUNCIONAMIENTO CON TERMOSTATO AMBIENTE

Cuando la estufa es gestionada mediante un termostato (o cronotermostato) externo, el instalador debe haber programado la configuración 1.

En esta configuración la estufa se apaga cuando el termostato externo alcanza la temperatura programada (circuito abierto) o bien modula

su funcionamiento (es decir la estufa intenta mantener la temperatura deseada consumiendo lo menos posible) al alcanzar la temperatura programada para el agua.

La estufa se reenciende automáticamente cuando la temperatura desciende por debajo del valor programado en el termostato externo (circuito cerrado).

 En el primer encendido, o cuando el apagado se produce directamente desde la estufa (botón ), se deberá proceder a encender la estufa directamente desde el panel de mando.



La estufa se apaga también si la temperatura del agua sigue aumentando a pesar de la modulación. En este caso la estufa se enciende solo si la diferencia entre la temperatura seleccionada y la temperatura real es mayor de 20°C.

Por eso, en esta configuración, nosotros aconsejamos de seleccionar un valor de temperatura del agua bastante alto (ej. 70°C).

3.5 FUNCIONAMIENTO CON Sonda AMBIENTE A BORDO CALDERA

La caldera puede encenderse/apagarse manualmente o en el modo programado.

En este tipo de configuración, la caldera modula la potencia en función de la temperatura ambiente leída por la sonda a bordo (es decir la caldera intenta mantener la temperatura deseada consumiendo lo menos posible).

Ante la posibilidad que el usuario haya habilitado la función "Eco-mode" en el submenú [7] del menú setup , en lugar de modular, la caldera se apaga cuando alcanza la temperatura programada y se reenciende cuando la temperatura ambiente desciende por debajo del delta indicado en el submenú [7] del menú setup .



Es posible programar la temperatura deseada en el ambiente en el menú temperatura .

Mediante el submenú [6] del menú setup  es posible programar la temperatura deseada del agua de entrada (pedir al instalador termohidráulico que sugiera la temperatura más adecuada para el equipo de calentamiento).

3.6 FUNCIONAMIENTO EN COMBINACIÓN CON UN DEPÓSITO

Para el funcionamiento en combinación con un depósito, el instalador habrá programado la configuración de funcionamiento 3 o 4 según si se trata de depósito con o sin serpentina interna.

La caldera es comandada por la temperatura leída por la sonda del depósito.

Cuando se alcanza la temperatura programada del depósito, en el menú temperatura  la caldera se apaga y se reenciende si la temperatura desciende por debajo del delta indicado en el submenú [8] del menú setup .

En esta configuración se puede programar también la función anticongelación.

3.7 FUNCIONAMIENTO EN COMBINACIÓN AL SISTEMA "EVERSPRING"



Antes de usar el producto en combinación con el sistema "Everspring" asegúrese de haber leído toda la documentación suministrada con la instalación y de haber recibido adecuadas instrucciones del instalador sobre el funcionamiento de la instalación misma y de la eventual unidad de enfriamiento.

Cuando la estufa se conecta al sistema Everspring, se debe configurar en 5.







En dicha configuración se puede encender/apagar manualmente o de manera programada.

La estufa puede funcionar en modalidad invernal (por defecto) o en modalidad estival, si el sistema Everspring cuenta también con una modalidad de enfriamiento.



Mediante el menú de la ventilación , el usuario puede modificar la velocidad del aire caliente/frío mediante la unidad Everspring.

3.7.1 Funcionamiento Invernal

Para pasar del funcionamiento estival al invernal, con la estufa apagada (fría) pero alimentada:

- Ir con las teclas   al menú potencia  y presionar la tecla ;
- Parpadeará el valor "SUN"; modificarlo con la tecla  hasta llevarlo a un valor entre 1 y 5;
- Presione la tecla  para confirmar la elección.

En este tipo de configuración, la caldera modula la potencia en función de la temperatura ambiente leída por la sonda a bordo del sistema Everspring (es decir la caldera intenta mantener la temperatura deseada consumando lo menos posible).







En la eventualidad que el usuario haya habilitado la función "Eco-mode" en el submenú [7] del menú setup , la caldera en vez de modular, se apaga al alcanzar la temperatura configurada, y se vuelve a encender cuando la temperatura ambiente baja por debajo del delta indicado en el submenú [8] del menú setup .

Se puede configurar la temperatura deseada en el ambiente en el menú temperatura .

En el submenú [6] del menú setup  se puede configurar la temperatura deseada del agua de envío (se recomienda configurar dicha temperatura alrededor de los 70°C).



3.7.2 Funcionamiento Estival (para usar si existe una unidad de enfriamiento combinada con Everspring)

Para pasar al funcionamiento estival es suficiente, con la estufa apagada (fría) pero alimentada:

- Ir con las teclas   al menú potencia  y presionar la tecla ;
- Parpadeará el valor actual; modificarlo con la tecla  hasta llevarlo al valor "SUN";
- Presione la tecla  para confirmar la elección.



Configure la temperatura estival deseada en el ambiente con el menú temperatura .

En esta modalidad, la estufa enciende la unidad de enfriamiento cuando la temperatura ambiente supera la temperatura configurada en el menú temperatura  y apaga la unidad cuando la temperatura ambiente baja por debajo del delta indicado en el submenú [8] del menú setup .



Después de haber configurado el funcionamiento estival, para habilitar el funcionamiento es necesario presionar la tecla de encendido  en el panel de mandos.

4 FUNCIONES DISPONIBLES

4.1 FUNCIÓN TEMPORIZADOR

Con esta función se pueden programar, habilitar y asignar a los diferentes días de la semana, los programas personalizados para el encendido y/o el apagado automático de la estufa.

Es posible programar hasta seis programas personalizados.

Para cada programa se pueden programar: hora de encendido, hora de apagado y temperatura deseada.

A cada día de la semana se le puede asignar hasta tres programas.

Los días de la semana se identifican por los números: Lunes = "d1", Martes = "d2";...; Domingo = "d7".

4.1.1 Configuración programas

- Usando los botones ◀ ▶ ir al menú setup  y pulsar el botón ⏪;
- Seleccionar la contraseña "7" con el botón + y confirmar con el botón ⏪;
- Seleccionar el submenú [2] y confirmar con el botón ⏪;
- Pasar con los botones + - los programas P1...P6; seleccionar con el botón ⏪ lo que se desea modificar;
- Parpadeará el valor de la hora de encendido, modificar el valor con los botones + - y presionar el botón ▶;
- Parpadeará el valor de los minutos, modificar el valor con los botones + - y presionar el botón ▶;
- Parpadeará el valor de la hora de apagado, modificar el valor con los botones + - y presionar el botón ▶;
- Parpadeará el valor de los minutos, modificar el valor con los botones + - y presionar el botón ▶;
- Parpadeará el valor de la temperatura deseada, modificar el valor con los botones + - y presionar el botón ▶;
- Presionar el botón ⏪ para confirmar los datos programados.

4.1.2 Asignar los programas a los días

Con esta función se pueden asignar hasta tres programas diferentes a un solo día.

- Usando los botones ◀ ▶ ir al menú setup  y pulsar el botón ⏪;
- Seleccionar la contraseña "7" con el botón + y confirmar con el botón ⏪;
- Seleccionar el submenú [1] y confirmar con el botón ⏪;
- Elegir con los botones + - el día [d1]...[d7] al cual se desean asociar los programas;
- Seleccionarlo con el botón ⏪;
- Parpadeará el valor del primer programa a asignar: P1...P6 o bien "OFF" para deshabilitarlo;
- Modificar el valor con los botones + - y presionar el botón ▶;
- Parpadeará el valor del segundo programa a asignar: P1...P6 o bien "OFF" para deshabilitarlo;
- Modificar el valor con los botones + - y presionar el botón ▶;
- Parpadeará el valor del tercer programa a asignar: P1...P6 o bien "OFF" para deshabilitarlo;
- Modificar el valor con los botones + - y presionar el botón ⏪ para confirmar los datos programados.

4.1.3 Habilitación/deshabilitación temporizador

- Usando los botones flecha ◀ ▶ ir al menú Temporizador ;
- Seleccionarlo con el botón ⏪;
- Pasar con los botones + - y seleccionar: "ON" para habilitar el temporizador o bien "OFF" para deshabilitarlo;
- Presionar el botón ⏪ para confirmar la selección.

Cuando el temporizador está habilitado aparece el icono fijo  para indicar que el temporizador está activo.

4.2 FUNCIÓN AHORRO “ECO MODE”

Habilitando esta función cuando la estufa alcanza la temperatura deseada en el ambiente, se apaga. Si dicha función no es habilitada, la estufa modula su funcionamiento para mantener la temperatura deseada consumiendo lo menos posible. La función “Eco Mode” está disponible sólo en la configuración 2.

Para habilitar/deshabilitar dicha función:

- Usando los botones ◀ ▶ ir al menú setup  y pulsar el botón ⏪;
- Seleccionar la contraseña “7” con el botón + y confirmar con el botón ⏪;
- Seleccionar el submenú [7] y confirmar con el botón ⏪.
- Programar con los botones + - no de los siguientes valores:
 - Eco → Activa la función “Eco Mode”
 - Off → Disactiva la función “Eco Mode”
- Presionar el botón ⏪ para confirmar los datos programados.



4.3 REENCENDIDO DESPUÉS DEL BLACK-OUT

En caso de interrupción momentánea de corriente eléctrica, la estufa se volverá a encender automáticamente, comprobando las condiciones de seguridad al volver la alimentación.

4.4 FUNCIÓN “BLOQUEO BOTONERA”

Con esta función es posible bloquear el uso del panel de mando para evitar modificaciones accidentales.

Para habilitar/deshabilitar dicha función:

- Usando los botones ◀ ▶ ir al menú setup  y pulsar el botón ⏪;
- Seleccionar la contraseña “7” con el botón + y confirmar con el botón ⏪;
- Seleccionar el submenú [10] y confirmar con el botón ⏪;
- Programar con los botones + - uno de los siguientes valores:
 - “Off” Bloqueo botonera desactivado
 - “Lo” Queda habilitado sólo el botón de encendido/apagado 
 - “Hi” Bloqueo botonera activado
- Presionar el botón ⏪ para confirmar los datos programados.

4.5 FUNCIÓN ANTICONGELACIÓN

En las configuraciones de instalación 2, 3 y 4 es posible programar una temperatura mínima por debajo de la cual la caldera se enciende (fuera de las franjas horarias programadas).

Configuración 2:

Para modificar el valor de la temperatura “anticongelación”:

- Usando los botones ◀ ▶ ir al menú setup  y pulsar el botón ⏪;
- Seleccionar la contraseña “7” con el botón + y confirmar con el botón ⏪;
- Seleccionar el submenú [9] y confirmar con el botón ⏪.
- Parpadeará el valor, modificarlo con los botones + - (OFF; 3...20°C);
- Presionar el botón ⏪ para confirmar el dato programado.

Configuración 3 e 4:

Para modificar el valor de la temperatura “anticongelación”:

- Usando los botones ◀ ▶ ir al menú setup  y pulsar el botón ⏪;
- Seleccionar la contraseña “7” con el botón + y confirmar con el botón ⏪;
- Seleccionar el submenú [9] y confirmar con el botón ⏪.
- Parpadeará el valor, modificarlo con los botones + - (OFF; 3...50°C);
- Presionar el botón ⏪ para confirmar el dato programado.

Si en el punto d se programa el valor “OFF”, esta función es deshabilitada.

4.6 FUNCIÓN DELTA DE REENCENDIDO

Delta de reencendido (en las configuraciones de instalación 2, 3, 4 y 5): es el número de grados centígrados por debajo de la temperatura de apagado superado el cual la estufa se reenciende automáticamente. Por ejemplo, si la estufa se programa para que se apague a 20°C (Modo Eco activo) y se programa un "Delta de reencendido" de 4°C, la estufa se reencenderá cuando registre una temperatura inferior o igual a 16°C.

Configuración 2 - 5:

Para modificar el valor del delta de reencendido:

- Usando los botones ◀ ▶ ir al menú setup  y pulsar el botón ↵;
- Seleccionar la contraseña "7" con el botón + y confirmar con el botón ↵;
- Seleccionar el submenú [8] y confirmar con el botón ↵;
- Parpadeará el valor; modificarlo con los botones + y - (0,5 ... 5,0°C);
- Presionar el botón ↵ para confirmar el dato programado.

Configuración 3 - 4:

Para modificar el valor del delta de reencendido:

- Usando los botones ◀ ▶ ir al menú setup  y pulsar el botón ↵;
- Seleccionar la contraseña "7" con el botón + y confirmar con el botón ↵;
- Seleccionar el submenú [8] y confirmar con el botón ↵;
- Parpadeará el valor; modificarlo con los botones + y - (0 ... 40°C);
- Presionar el botón ↵ para confirmar el dato programado.

4.7 ACTIVACIÓN MANUAL DEL SISTEMA DE CARGA

En caso de primer uso (tanque pellet inicialmente vacío), o para testear el funcionamiento del grupo de carga, se puede accionar manualmente la carga.

En el panel de mandos de la estufa:



- Actuando en las teclas con las flechas ◀ ▶ ir al menú setup  y presione la tecla ↵;
- Seleccionar la contraseña "7" con la tecla + y confirmar con la tecla ↵;
- Correr con la tecla + y seleccionar el submenú [31];
- Seleccionar la contraseña "54" con la tecla + y confirmar con la tecla ↵;
- Teniendo presionada la tecla ↵ el sistema de carga se activará y en la pantalla se visualizarán las barras de aumento.
- Volviendo a dejar la tecla finalizará la operación de carga.

¡Atención!

- Esta función se activa sólo con la estufa apagada y fría.
- Antes de un nuevo encendido asegúrese que en el brasero no haya pellet.

5 GESTIÓN DE LAS ALARMAS

Si se produce una anomalía en el funcionamiento, se activa el siguiente procedimiento:

- 1) Alarma acústica (beep);
- 2) Se ilumina uno de los siguientes led de sistema:   .
- 3) Si la anomalía se refiere a un error, la estufa se apagará.

La presión prolongada del botón “anular”  permite la visualización en el visor del código de error:

CÓDIGO ERROR/AVISO	DESCRIPCIÓN	POSIBLES CAUSAS	LED
E001	Panel de mando defectuoso	Defecto del panel de mando	
E002	Error de comunicación señal de mando a distancia	Defecto del panel de mando	
E004	Error de comunicación	Cable de conexión entre la tarjeta y el panel de mando interrumpido o desconectado. Si aparece durante el cambio de configuración, ignorar dicho error.	
E101	Error de no encendido Agua de entrada muy caliente	Faltan pellets Calidad del pellet Sistema de encendido averiado Brasero sucio Problemas en la instalación de calefacción Problemas en el circulador	
E105	Malfuncionamiento sonda de temperatura	Sonda agua de retorno defectuosa	
E106	Malfuncionamiento sonda de temperatura	Sonda puffer defectuosa	
E108*	Error de seguridad	Tapa o puerta de carga abierta	
E108**	Error dispositivo de seguridad térmica	Problemas en la instalación de calefacción Problemas en el circulador Problemas de sobrecalentamiento del depósito pellet	
E109*	Error de presión o seguridad térmica	Sistema de expulsión de humos sucio Juntas estancas desgastadas Aire de combustión insuficiente Problemas en el sistema de calefacción Problemas en la bomba de circulación Problemas de recalentamiento del depósito de pellet	
E109**	Error de presión	Sistema de evacuación humos sucio Guarniciones de estanqueidad gastadas Aire comburente insuficiente	
E110	Malfuncionamiento sonda de temperatura	Sonda agua de entrada defectuosa Sonda aire defectuosa	
E111	Malfuncionamiento sonda humos	Sonda temperatura humos defectuosa	
A001	Nivel pellet bajo (<i>icono intermitente</i>)	Pellet acabándose	
A002	Aviso de mantenimiento programado (<i>icone lampeggianti</i>)	Periódicamente la estufa indica que se debe realizar un mantenimiento por parte de un técnico especializado	
A007	Malfuncionamiento sensor de presión. (<i>iconos intermitentes</i>)	Sensor de presión o tarjeta averías	
----	Limpieza estufa	Cámara de combustión, brasero o sistema de evacuación de humos. Tubos registro de presión separados u obstruidos. Entrada del aire comburente obstruida.	
----	Error de no encendido	Pellet agotados, Resistencia de encendido averiada, Guarniciones gastadas, Posición del brasero incorrecta	

* Solo en las estufas con micro interruptores de seguridad en la puerta del hogar y en la tapa del contenedor de pellets.

** Solo en las estufas sin micro interruptores de seguridad en la puerta del hogar y en la tapa del contenedor de pellets.

Después de comprobar el tipo de mensaje es posible reajustar la alarma presionando algunos instantes el botón de encendido/apagado .

Ante la eventualidad que el código error sea “E108 o E109”, antes de reajustar la alarma, reactivar el termostato de rearme manual situado en la parte posterior de la estufa (Fig. 11.1).

A partir de aquí será posible realizar un nuevo encendido.



Fig.5.1

PALAZZETTI

IL CALORE CHE PIACE ALLA NATURA

Palazzetti Lelio s.p.a.

Via Roveredo, 103
cap 33080 - Porcia (PN) - ITALY
Internet: www.palazzetti.it

Per conoscere il centro di assistenza tecnica
(CAT) più vicino a te consulta il sito

www.palazzetti.it

oppure chiama il numero



La Ditta Palazzetti non si assume alcuna responsabilità per eventuali errori del presente opuscolo e si ritiene libera di variare senza preavviso le caratteristiche dei propri prodotti.

Palazzetti accepts no liability for any mistakes in this handbook and is free to modify the features of its products without prior notice.

Die Firma Palazzetti übernimmt für eventuelle Fehler in diesem Heft keine Verantwortung und behält sich das Recht vor, die Eigenschaften ihrer Produkte ohne Vorbescheid zu ändern.

Palazzetti décline toute responsabilité en cas d'erreurs dans la présente documentation et conserve la faculté de modifier sans préavis les caractéristiques de l'appareil.

La empresa Palazzetti no se responsabiliza de los errores eventuales de este manual y tiene el derecho de modificar sin previo aviso las características de sus productos.

Proizvajalec Palazzetti ne prevzema odgovornosti za morebitne napake v tem zvezku in si pridruzuje pravico do vnosa sprememb na svojih izdelkih brez predhodnega obvestila.