

PALAZZETTI

IL CALORE CHE PIACE ALLA NATURA

IT UTILIZZO E FUNZIONALITÀ

EN USE AND FUNCTION

DE VERWENDUNG UND BETRIEB

FR UTILISATION ET FONCTIONNEMENT

ES USO Y FUNCIONES

MULTIFIRE IDRO (GS) NT 15 - NT 22

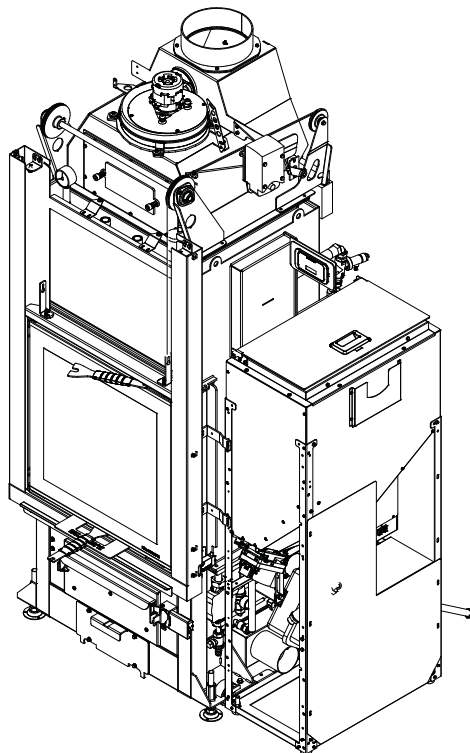

*Il presente manuale è parte integrante del prodotto.
Si raccomanda di leggere attentamente le istruzioni prima
dell'installazione, manutenzione o utilizzo del prodotto.*

*This manual is an integral part of the product.
Read the instructions carefully before installing, servicing or
operating the product.*

*Die vorliegende Anleitung ist fester Bestandteil des Produkts.
Vor der Installation, Wartung und Verwendung die Anleitungen
stets aufmerksam durchlesen.*

*Le présent manuel fait partie intégrante du produit.
Il est conseillé de lire attentivement les consignes
avant l'installation, l'entretien ou l'utilisation du produit.*

*Este manual es parte integrante del producto.
Se recomienda leer detenidamente las instrucciones antes
de la instalación, el mantenimiento y el uso del producto..*

IT

Gentile cliente,
desideriamo innanzitutto ringraziarLa per la preferenza che ha voluto accordarci acquistando il nostro prodotto e ci congratuliamo con Lei per la scelta.

Per consentirLe di utilizzare al meglio la Sua nuova stufa, la invitiamo a seguire attentamente quanto descritto nel presente manuale.

EN

Dear Customer,
We'd like to thank you for having purchased one of our products and congratulate you on your choice.

To make sure you get the most out of your new stove, please carefully follow the instructions provided in this manual.

DE

Sehr geehrter Kunde,
Zuallererst möchten wir Ihnen für den uns gewährten Vorzug danken und Ihnen zur Wahl gratulieren.

Damit Sie Ihren neuen Heizofen so gut wie möglich benutzen können, bitten wir Sie, die in dieser Bedienungs- und Wartungsanleitung enthaltenen Angaben genau zu befolgen.

FR

Cher client,
Nous souhaitons avant tout vous remercier de la préférence que vous nous avez accordée en achetant notre produit et vous félicitons pour votre choix.

Afin de vous permettre de profiter au mieux de votre nouveau poêle, nous vous invitons à suivre attentivement les instructions reportées dans cette notice.

ES

Estimado Cliente,
Deseamos agradecerle por la preferencia que nos ha otorgado adquiriendo nuestro producto y lo felicitamos por su elección.

Para el mejor uso de su nueva estufa, lo invitamos a leer con atención cuanto se describe en el presente manual.

INDICE

1 PANNELLO COMANDI

- 1.1 DESCRIZIONE
- 1.2 USO DEL PANNELLO COMANDI
- 1.3 PARAMETRI DI FUNZIONAMENTO

2 OPERAZIONI PRELIMINARI

- 2.1 CARICAMENTO PELLETT
- 2.2 ALIMENTAZIONE ELETTRICA
- 2.3 IMPOSTAZIONI INIZIALI

3 UTILIZZO DEL PRODOTTO

- 3.1 PREMESSA
- 3.2 ACCENSIONE
- 3.3 MODIFICA DEI PARAMETRI
- 3.4 CAMBIO COMBUSTIBILE
- 3.5 SPEGNIMENTO
- 3.6 FUNZIONAMENTO CON TERMOSTATO AMBIENTE (SOLO A PELLETT)
- 3.7 FUNZIONAMENTO CON SONDA AMBIENTE A BORDO CALDAIA
- 3.8 FUNZIONAMENTO IN ABBINAMENTO CON UN ACCUMULO

4 FUNZIONI DISPONIBILI

- 4.1 TIMER
- 4.2 FUNZIONE RISPARMIO "ECO MODE" (SOLO A PELLETT)
- 4.3 FUNZIONE DELTA DI RIACCENSIONE
- 4.4 FUNZIONE AUTONOMIA
- 4.5 FUNZIONE RIFORNIMENTO
- 4.6 RIACCENSIONE DOPO IL BLACK-OUT
- 4.7 FUNZIONE "BLOCCO TASTIERA"
- 4.8 FUNZIONE ANTIGELO
- 4.9 ATTIVAZIONE MANUALE DEL SISTEMA DI CARICAMENTO PELLETT
- 4.10 ATTIVAZIONE MANUALE DEL SISTEMA MECCANICO DI PULIZIA BRACIERE

5 GESTIONE DEGLI ALLARMI

- 5.1 DESCRIZIONE DEI MESSAGGI
- 5.2 RESET DEGLI ALLARMI

1 PANNELLO COMANDI

Prima di procedere con la lettura del Manuale, prendere visione della descrizione della stufa contenuta nel “Libretto Prodotto” allegato.

1.1 DESCRIZIONE

Il pannello comandi è composto da:







- A) una parte superiore con i led di stato e le icone retroilluminate che identificano ciascuna funzione;
- B) display a led;
- C) tasto di accensione (🔥);
- D) tasto “Annulla” e visualizzazione “errore” (⏪);
- E) due tasti freccia per spostarsi tra le varie funzioni (⏪ ⏩);
- F) due tasti (+) e (-) per modificare i parametri di funzionamento e accedere ai sottomenu;
- G) un tasto di invio (↵) per la conferma del parametro o della selezione









Fig. 1.1

 *Tutti i tasti sono di tipo capacitivo, pertanto non necessitano di una pressione per essere attivati, ma è sufficiente sfiorarne la superficie.*

1.1.1 Led di stato

ICONA	AVVISO	DESCRIZIONE
	Pellet in esaurimento	Indica che è necessario ricaricare il serbatoio di pellet
	Manutenzione	Indica la necessità di effettuare una manutenzione (può apparire anche quando c'è una pressione ripetuta del tasto ON)
	Assistenza	Indica la presenza di un errore
	Ricevitore del telecomando	Riceve i comandi dal telecomando (opzionale).
	Timer attivo	Indica se è attiva la funzione timer.
	Led di segnalazione stato (vicino al tasto 🔥)	Led sempre acceso: stufa accesa e in lavoro Led intermittente: stufa in fase di accensione o in stand-by Led spento: stufa spenta

1.1.2 Descrizione dei menu

ICONA	FUNZIONE	DESCRIZIONE	VALORI
	Potenza	Impostazione della potenza di funzionamento	1..5
	Ventilazione	Nei modelli ad acqua questo parametro non è attivato	
	Temperatura	Visualizza la temperatura letta dalla sonda* e permette di impostare la temperatura desiderata. *config.1: sonda di mandata; config.2: sonda ambiente; config. 3-4: sonda esterna/accumulo.	config.1: 65..80 °C config.2: 10.. 48 °C config.3-4: 45..75 °C
	Combustibile	[PELL]=Pellet [W]=Legna	
	Timer	Abilita o disabilita il Timer. Quando è abilitato verrà visualizzata l'icona fissa 	ON - OFF

ICONA	FUNZIONE	SOTTOMENU	DESCRIZIONE	VALORI
	Setup	[1] Timer settimanale	Assegnazione dei programmi (max 3) ai vari giorni della settimana	[d1] ... [d7]
		[2] Programmi	Menu di impostazione dei programmi	[P1] ... [P6]
		[3] Orologio / data	Impostazione orologio e data	
		[4] Ore Residue	Visualizza le ore mancanti alla manutenzione consigliata. Con il valore "Hi" si indica un numero superiore alle 999 ore.	
		[5] Informazioni di sistema	Visualizza la versione software corrente	
		[6] Temperatura acqua	Consente di impostare la temperatura desiderata per l'acqua di mandata (solo in configurazione 2)	60 ... 80°C
		[7] Funzione Eco	Abilita o meno l'Eco Mode che comporta lo spegnimento e la riaccensione automatica in funzione della temperatura ambiente (solo in configurazione 2)	OFF; Eco
		[8] Delta di riaccensione	Differenza di gradi, rispetto alla temperatura di spegnimento al di sotto della quale la stufa si riaccende (escluso in configurazione 1).	0,5 ... 5,0°C 0 ... 40°C
		[9] Temperatura antigelo	Temperatura minima al di sotto della quale la stufa si accende (escluso in configurazione 1).	OFF; 3 ... 20 °C OFF; 3 ... 50 °C
		[10] Blocco tastiera	Imposta la modalità di blocco dei tasti	OFF; Lo; Hi
		[11] Luminosità display	Imposta il grado di luminosità del display	OFF; 1 ... 5
		[12] Modalità display	Imposta la modalità di visualizzazione dei dati	OFF; 1 ... 4
		[13] Volume cicalino	Imposta il volume dell'avviso acustico	OFF; 1 ... 5
		[14] Tipologia pellet	E' possibile impostare 3 diverse tipologie di pellet	1 ... 3
		[30] Menu Installatore	Modifica/Visualizza la configurazione della stufa	PWD: "54"
		[31] Caricamento pellet	Attivazione manuale del sistema di caricamento pellet	
[32] Scuoti braciere	Attivazione manuale del sistema meccanico di pulizia braciere			
[33] Alimentazione pompa	Menu di competenza del centro di assistenza			
[40] Menu di servizio	Menu di competenza del centro di assistenza			

I sottomenu [30] e [40] del menu Setup sono protetti da password e sono ad uso esclusivo del centro di assistenza tecnico.

1.2 USO DEL PANNELLO COMANDI

- Agendo sui tasti freccia ◀ ▶ ci si sposta tra i diversi menu che si illuminano di volta in volta.
- Soffermendosi su una determinata funzione basta agire sul tasto ↵ e modificarne i valori, con i tasti + -.
- Una ulteriore pressione del tasto ↵ conferma la modifica.
- In generale tutti i valori lampeggianti sono in quel momento modificabili con i tasti + -.
- Il tasto “annulla” ⇩ consente di annullare la modifica; la sua pressione prolungata permette di visualizzare sul display un eventuale codice di allarme o di errore.

1.3 PARAMETRI DI FUNZIONAMENTO

Il funzionamento della stufa è determinato dai parametri di Potenza e Temperatura impostati dall'utente.

1.3.1 Modifica della potenza

La potenza definisce la quantità di calore prodotta dalla stufa e quindi incide direttamente anche sui consumi. Per modificare la potenza portarsi con i tasti ◀ ▶ sul menu potenza 🔥

- a) Scorrere con i tasti + - il sottomenu
- b) Selezionare il sottomenu “1” e confermare con il tasto ↵.
- c) Lampeggerà il valore di potenza; modificarne il valore con i tasti + - (1 minimo, ..., 5 massimo)
- d) Premere il tasto ↵ per confermare i dati impostati.

1.3.2 Modifica della temperatura

In funzione della configurazione installativa è possibile intervenire su diversi valori di temperatura:

- a) Portarsi con i tasti ◀ ▶ sul menu temperatura 🌡️ e premere il tasto ↵;
- b) Lampeggerà il valore attuale; modificarlo con i tasti + -;
- c) Premere il tasto ↵ per confermare il dato impostato.

Temperatura acqua (solo nella configurazione installativa 1): variando questo valore si varia la temperatura desiderata di mandata dell'acqua calda da parte della caldaia.

Temperatura ambiente (solo nella configurazione installativa 2): modificando tale valore si definisce la temperatura che si desidera raggiungere in ambiente, letta direttamente da una sonda posta sulla caldaia.

Temperatura accumulo (solo nelle configurazioni installative 3 e 4): identifica la temperatura minima che si desidera mantenere all'interno dell'accumulo.

2 OPERAZIONI PRELIMINARI

2.1 CARICAMENTO PELLET

La prima operazione da eseguire prima di accendere il prodotto è quella di riempire il serbatoio di combustibile (pellet) utilizzando preferibilmente una apposita paletta.

Non svuotare il sacco direttamente nel serbatoio per evitare di caricare della segatura o altri elementi estranei che potrebbero compromettere il buon funzionamento della stufa e per evitare di disperdere il pellet al di fuori del serbatoio.

☞ Assicurarsi di richiudere bene il coperchio del serbatoio dopo aver effettuato l'operazione di caricamento del pellet.

☞ Se si vuole sfruttare la funzione di "autonomia", a questo punto, portarsi con i tasti freccia (◀ ▶) sull'icona combustibile (🔥) e premere invio (↵). Selezionare con i tasti (+ -) la dicitura "FULL" e premere invio (↵).

Se si vuole disabilitare tale funzione, invece di "FULL" selezionare "OFF".

2.2 ALIMENTAZIONE ELETTRICA

Collegare il prodotto alla rete elettrica e agire sull'interruttore di accensione posizionandolo su "1" (Fig. 2.1- A). Se il collegamento è corretto la stufa emette una serie di segnali acustici intermittenti, si accende il display.

! Per lunghi periodi di inutilizzo, si consiglia di posizionare l'interruttore in posizione di OFF (0).

☞ Assicurarsi di non toccare il pannello di comando nel momento in cui viene data alimentazione alla stufa.

⚠ Il funzionamento della stufa è subordinato ad una corretta alimentazione elettrica. In caso di mancanza di energia elettrica non accendere la stufa!

2.3 IMPOSTAZIONI INIZIALI

Prima di utilizzare la stufa è necessario impostare la data e l'ora corrente.

2.3.1 Impostazione orario e data

Per modificare la data:

- Portarsi con i tasti (◀ ▶) sul menu setup (⚙️) e premere il tasto (↵)
- Selezionare la password "7" con il tasto (+) e confermare con il tasto (↵);
- Scorrere con il tasto (+), selezionare il sottomenu [3] e confermare con il tasto (↵);
- Lampeggerà il valore dell'ora; modificarne il valore con i tasti (+ -) e premere il tasto (▶);
- Lampeggerà il valore dei minuti; modificarne il valore con i tasti (+ -) e premere il tasto (▶);
- Lampeggerà il valore del giorno; modificarne il valore con i tasti (+ -) e premere il tasto (▶);
- Lampeggerà il valore del mese; modificarne il valore con i tasti (+ -) e premere il tasto (▶);
- Lampeggerà il valore dell'anno; modificarne il valore con i tasti (+ -) e premere il tasto (▶);
- Lampeggerà il valore del giorno attuale della settimana (Lunedì = 1 ... Domenica = 7); modificarne il valore con i tasti (+ -);
- Premere il tasto (↵) per confermare i dati impostati.

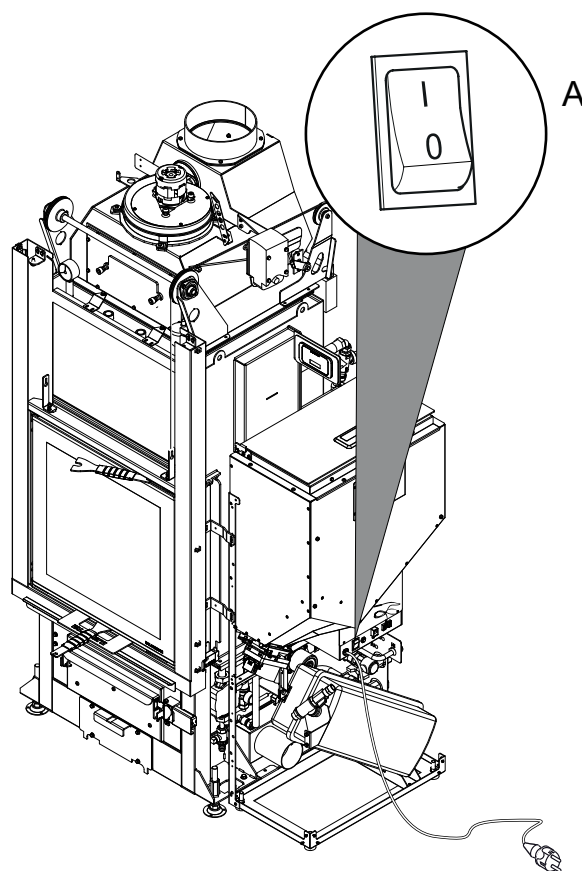

Fig. 2.1

2.3.2 Impostazione luminosità display

E' possibile impostare il grado di attenuazione della luminosità del display quando è nella modalità standby.

- a) Agendo sui tasti freccia ◀ ▶ portarsi sul menu setup ⚙ e premere il tasto ↵;
- b) Selezionare la password "7" con il tasto + e confermare con il tasto ↵;
- c) Scorrere con il tasto + e selezionare il sottomenu [1 1] e confermare con il tasto ↵;
- d) Impostare con i tasti + e - il valore di luminosità desiderato (OFF, 1 ... 5) e confermare con il tasto ↵.

2.3.3 Impostazione modalità display

E' possibile impostare cosa si vorrà visualizzare sul display quando quest'ultimo è nella modalità standby

- a) Agendo sui tasti freccia ◀ ▶ portarsi sul menu setup ⚙ e premere il tasto ↵;
- b) Selezionare la password "7" con il tasto + e confermare con il tasto ↵;
- c) Scorrere con il tasto + e selezionare il sottomenu [1 2] e confermare con il tasto ↵;
- d) Impostare con i tasti + e - uno dei seguenti valori:
 - "OFF" • Il display resterà fisso sull'ultima visualizzazione operata dall'utente;
 - "1" • Verranno visualizzati ciclicamente tutti i parametri di funzionamento;
 - "2" • Viene visualizzata la temperatura (letta dalla sonda ambiente)
 - "3" • Viene visualizzata l'ora corrente
 - "4" • Viene visualizzata l'autonomia in ore prima di dover ricaricare il serbatoio, se la funzione rifornimento è stata abilitata, oppure viene visualizzato il simbolo  se si è in funzionamento a legna.
- e) Premere il tasto ↵ per confermare i dati impostati.

2.3.4 Impostazione volume

E' possibile impostare il livello di volume del cicalino, in base alle proprie necessità:

- a) Agendo sui tasti freccia ◀ ▶ portarsi sul menu setup ⚙ e premere il tasto ↵;
- b) Selezionare la password "7" con il tasto + e confermare con il tasto ↵;
- c) Scorrere con il tasto + e selezionare il sottomenu [1 3] e confermare con il tasto ↵;
- d) Impostare con i tasti + e - il livello di volume desiderato (OFF, 1 ... 5) e confermare con il tasto ↵.

2.3.5 Impostazione tipologia di pellet

E' possibile impostare la tipologia di pellet che si va ad utilizzare:

- a) Agendo sui tasti freccia ◀ ▶ portarsi sul menu setup ⚙ e premere il tasto ↵;
- b) Selezionare la password "7" con il tasto + e confermare con il tasto ↵;
- c) Scorrere con il tasto + e selezionare il sottomenu [1 4] e confermare con il tasto ↵;
- d) Impostare con i tasti + e - uno dei seguenti valori:
 - "1" • Pellet standard (En Plus)
 - "2" • Pellet lungo
 - "3" • Pellet piccolo
- e) Premere il tasto ↵ per confermare i dati impostati.

3 UTILIZZO DEL PRODOTTO

3.1 PREMESSA

La stufa offre la possibilità di effettuare l'avvio della combustione in modo automatico (solo a pellet) o manuale (solo a legna).

L'avvio automatico a pellet può avvenire anche in modo programmato.

Nello stato di spento, la stufa è predisposta nella modalità legna indicata dal simbolo  (Fig.3.1).

Non toccare parti verniciate durante le prime accensioni per evitare danneggiamenti alla verniciatura.

! Durante la prima accensione della stufa si possono generare sgradevoli odori o fumi causati dall'evaporazione o dall'essiccamento di alcuni materiali utilizzati. Tale fenomeno andrà via via a scomparire.

! Si consiglia, durante le prime accensioni, di mantenere i locali ben arieggiati.

! **Ogni qual volta si apre la porta del focolare evitare di lasciarla aperta per un lungo periodo onde evitare che il sensore di chiusura notifichi lo stato di porta aperta, attraverso un allarme acustico.**

! Il funzionamento della stufa è subordinato ad una corretta alimentazione elettrica. In caso di mancanza di energia elettrica non accendere la stufa!

3.2 ACCENSIONE

3.2.1 Accensione manuale a legna

Operazioni da effettuare:

1. utilizzare la maniglia a disposizione e spingere verso l'alto (fig. 3.2);
2. posizionare della legna di piccola taglia sulla base del focolare, ponendo particolare attenzione a non ostruire il canale di caricamento del pellet;
3. posizionare un accendi-fuoco naturale sulla catasta, aggiungere sopra stecche di legna fine incrociate fra di loro e accendere dall'alto l'accendi-fuoco;
4. richiudere la portina spingendo l'anta verso il basso fino alla completa chiusura.

La stufa regola automaticamente il fabbisogno di aria comburente.

! PERICOLO

Per accendere il fuoco non usare mai alcool, benzina, cherosene, o altri combustibili liquidi. Tenere gli stessi lontano dal fuoco. Non usare zollette accendi-fuoco derivanti dal petrolio o di origine chimica.

Utilizzare esclusivamente zollette accendi-fuoco di tipo ecologico.

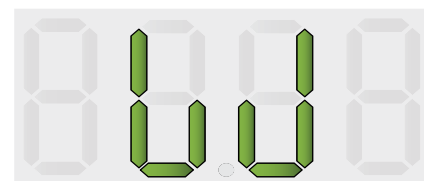

Fig. 3.1

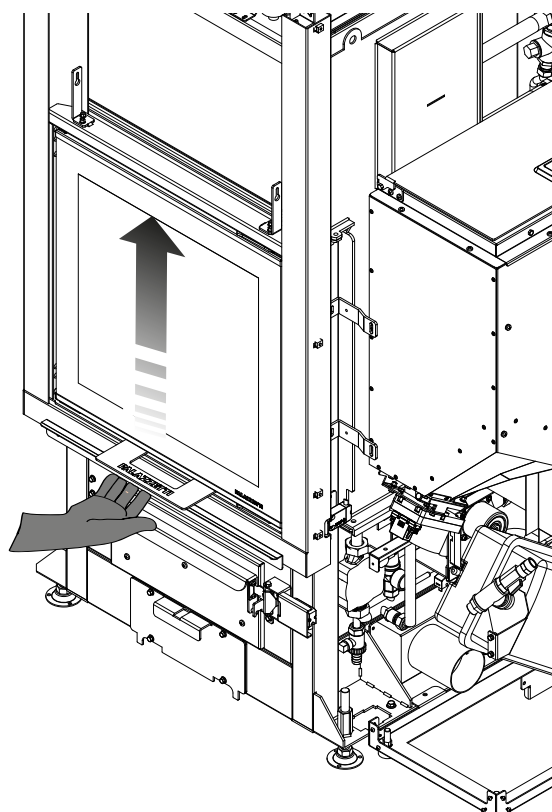



Fig. 3.2

La ricarica di legna va fatta preferibilmente quando la carica precedente si è ridotta allo stato di brace.

Non sovraccaricare di legna il focolare; attenersi nei limiti del consumo orario di combustibile indicato tra le caratteristiche tecniche.

Se durante il periodo di funzionamento a legna (stato ) è stato abilitato un programma di accensione a pellet, la stufa non passerà automaticamente a pellet fin tanto che la legna presente nel focolare non ha finito di bruciare. Al termine della combustione della legna viene effettuato un ciclo automatico di pulizia del braciere, e se il programma è ancora nella fascia oraria attiva, la stufa si accenderà a pellet.

3.2.2 Accensione automatica a pellet

Assicurarsi che il serbatoio pellet contenga una adeguata quantità di pellet.

Per accendere la stufa tenere premuto il tasto  per qualche secondo.

L'icona a forma di fiamma inizierà a lampeggiare, durante la fase di accensione, fino a restare fissa a stufa accesa.

! Accensione automatica: la stufa è dotata di un dispositivo automatico che consente l'accensione del pellet senza l'utilizzo di altri accenditori tradizionali.

3.3 MODIFICA DEI PARAMETRI DI FUNZIONAMENTO

E' possibile modificare i parametri di funzionamento della stufa secondo quanto riportato nel Paragrafo 1.3.



 I valori impostati verranno mantenuti fino alla successiva variazione, anche a stufa spenta o scollegata dall'alimentazione elettrica.



3.4 CAMBIO COMBUSTIBILE

La stufa offre la possibilità di poter cambiare tipologia di combustibile (legna/pellet) mentre la stufa è a regime.

3.4.1 Passaggio da Legna a Pellet

Se, durante il funzionamento a legna si vuole passare nel funzionamento automatico a pellet, è sufficiente tenere premuto il tasto  per qualche istante:

1. il led di accensione  comincerà a lampeggiare
2. al termine della combustione della legna la stufa effettuerà una operazione di pulizia
3. dopo la pulizia la stufa si porterà nel funzionamento a pellet ed il led di accensione  resterà fisso.

 Qualora si sia impostato il passaggio a pellet, tenere premuto per qualche istante il tasto  per disabilitare tale funzione (il led di accensione  non lampeggerà più e comparirà la scritta "OFF").

3.4.2 Passaggio da Pellet a Legna

Se, durante il funzionamento a pellet, si intende cambiare combustibile e passare a legna, sarà sufficiente:

1. aprire la portina;
2. caricare qualche ciocco di legna nel braciere ponendo particolare attenzione a non ostruire il canale di caricamento del pellet
3. richiudere la portina

Se si è effettuata una carica sufficiente di legna, la stufa dopo alcuni minuti si porterà automaticamente nel funzionamento a legna, pertanto sarà necessario ricaricare manualmente altro combustibile se si vuole mantenere la combustione.

Sul display appariranno sul menu del combustibile i simboli [PELL]= quando la stufa è in posizione Pellet e [W]= quando è in posizione legna. Sul display apparirà sul menu del combustibile il simbolo .

 E' necessario che durante la fase di caricamento della legna la portina resti aperta per un lasso di tempo superiore a 3 secondi per dare la possibilità alla stufa di accorgersi dell'operazione.

3.5 SPEGNIMENTO

3.5.1 Spegnimento a legna

Per spegnere la stufa quando è nello stato di funzionamento a legna, è sufficiente non caricare altro combustibile nel focolare.

Al termine della combustione della legna la stufa effettuerà un ciclo automatico di pulizia del braciere.

3.5.2 Spegnimento a pellet

Per spegnere la stufa, quando è nello stato di funzionamento a pellet, tenere premuto il tasto  per qualche secondo; l'icona a forma di fiamma si spegnerà.

Al termine della combustione, la stufa eseguirà un ciclo automatico di pulizia del braciere.

 Si raccomanda di spegnere la stufa seguendo scrupolosamente quanto sopra riportato ed evitare assolutamente di farlo togliendo l'alimentazione elettrica.

3.6 FUNZIONAMENTO CON TERMOSTATO AMBIENTE (SOLO A PELLETTI)

Quando la stufa viene comandata da un termostato (o cronotermostato) esterno, l'installatore deve avere impostato la configurazione 1.

In questa configurazione **la stufa si spegne** quando il termostato esterno è soddisfatto (circuito aperto) oppure modula il proprio funzionamento (cioè la stufa tenta di mantenere la temperatura desiderata consumando il meno possibile) al raggiungimento della temperatura dell'acqua, impostata.

La stufa si riaccende automaticamente quando la temperatura scende al di sotto del valore impostato sul termostato esterno (circuito chiuso).



Alla prima accensione, o qualora lo spegnimento sia avvenuto direttamente dalla stufa (tasto ), si dovrà procedere ad accendere la stufa direttamente dal pannello comandi.



La stufa si spegnerà anche nell'eventualità in cui la temperatura dell'acqua continui a crescere nonostante la modulazione. In questo caso la stufa si riaccenderà solo se la differenza di temperatura tra il valore impostato e quello reale è maggiore di 20°C.

È consigliabile pertanto, in questa configurazione, impostare la temperatura dell'acqua su un valore alto (es. 70°C).

3.7 FUNZIONAMENTO CON SONDA AMBIENTE A BORDO CALDAIA

Il prodotto può essere acceso/spento manualmente o in modo programmato.

In questo tipo di configurazione, la caldaia modula la potenza in funzione della temperatura ambiente letta dalla sonda a bordo (cioè la caldaia tenta di mantenere la temperatura desiderata consumando il meno possibile).

Nell'eventualità l'utente abbia abilitato la funzione "Eco-mode" nel sottomenu [7] del menu setup , la caldaia invece di modulare, si spegne al raggiungimento della temperatura impostata, e si riaccende quando la temperatura ambiente scende al di sotto del delta indicato nel sottomenu [8] del menu setup .

È possibile impostare la temperatura desiderata in ambiente nel menu temperatura .

Nel sottomenu [6] del menu setup  si può impostare la temperatura desiderata dell'acqua di mandata (farsi suggerire dal proprio installatore termoidraulico, la temperatura più confacente al proprio impianto di riscaldamento).

3.8 FUNZIONAMENTO IN ABBINAMENTO CON UN ACCUMULO

Per il funzionamento in abbinamento ad un accumulo l'installatore avrà impostato la configurazione di funzionamento 3 o 4 a seconda se si tratta di accumulo con o senza serpentino interno.

La caldaia viene comandata dalla temperatura letta dalla sonda nell'accumulo.

Al raggiungimento della temperatura dell'accumulo impostata nel menu temperatura  la caldaia si spegne e si riaccende se la temperatura scende al di sotto del delta indicato nel sottomenu [8] del menu setup .

In questa configurazione è possibile impostare anche la funzione antigelo.

4 FUNZIONI DISPONIBILI

4.1 TIMER

E' possibile impostare, abilitare ed assegnare ai vari giorni della settimana, i programmi personalizzati per l'accensione e/o lo spegnimento automatico della stufa.

























E' possibile configurare fino a sei programmi personalizzati.

Per ciascun programma si può impostare: ora di accensione, ora di spegnimento e temperatura desiderata.

A ciascun giorno della settimana è possibile assegnare fino a tre programmi.



















I giorni della settimana sono identificati da numeri: Lunedì = "d1", Martedì = "d2";...; Domenica = "d7".

4.1.1 Impostazione programmi







- Agendo sui tasti freccia   portarsi sul menu setup  e premere il tasto 
- Selezionare la password "7" con il tasto  e confermare con il tasto 
- Selezionare il sottomenu **[2]** e confermare con il tasto 
- Scorrere con i tasti  e  i programmi P1...P6; selezionare con il tasto  quello che si vuole modificare;
- Lampeggerà il valore dell'ora di accensione; modificarne il valore con i tasti  e  e premere il tasto 
- Lampeggerà il valore dei minuti; modificarne il valore con i tasti  e  e premere il tasto 
- Lampeggerà il valore dell'ora di spegnimento; modificarne il valore con i tasti  e  e premere il tasto 
- Lampeggerà il valore dei minuti; modificarne il valore con i tasti  e  e premere il tasto 
- Lampeggerà il valore della temperatura desiderata; modificarne il valore con i tasti  e 
- Premere il tasto  per confermare i dati impostati.

4.1.2 Assegnare i programmi ai giorni

Con questa funzione è possibile assegnare fino a tre programmi diversi ad un determinato giorno.

- Agendo sui tasti freccia   portarsi sul menu setup  e premere il tasto 
- Selezionare la password "7" con il tasto  e confermare con il tasto 
- Selezionare il sottomenu **[1]** e confermare con il tasto 
- Scegliere con i tasti  e  il giorno [d1]...[d7] al quale si vogliono associare i programmi;
- Selezionarlo con il tasto 
- Lampeggerà il valore del primo programma da assegnare: P1...P6 oppure "OFF" per disabilitarlo;
- Modificarne il valore con i tasti  e  e premere il tasto 
- Lampeggerà il valore del secondo programma da assegnare: P1...P6 oppure "OFF" per disabilitarlo;
- Modificarne il valore con i tasti  e  e premere il tasto 
- Lampeggerà il valore del terzo programma da assegnare: P1...P6 oppure "OFF" per disabilitarlo;
- Modificarne il valore con i tasti  e  e premere il tasto  per confermare i dati impostati.

4.1.3 Abilitazione/disabilitazione timer

- Agendo sui tasti freccia   portarsi sul menu Timer .
- Confermare con il tasto 
- Scorrere con i tasti  e  e selezionare: "ON" per abilitare il timer oppure "OFF" per disabilitarlo.
- Premere il tasto  per confermare la selezione.











Quando il timer è abilitato apparirà l'icona fissa  ad indicare che il timer è attivo.

4.2 FUNZIONE RISPARMIO “ECO MODE” (SOLO A PELLETT)

Abilitando questa funzione si fa in modo che la stufa, al raggiungimento della temperatura desiderata in ambiente, si spenga. Se tale funzione non è abilitata, la stufa modula il proprio funzionamento per mantenere la temperatura desiderata consumando il meno possibile.

La funzione “Eco Mode” è disponibile solo nella configurazione 2.

Per abilitare/disabilitare tale funzione:











- a) Agendo sui tasti freccia   portarsi sul menu setup  e premere il tasto .
- b) Selezionare la password “7” con il tasto  e confermare con il tasto .
- c) Selezionare il sottomenu [7] e confermare con il tasto .
- d) Impostare con i tasti  e  uno dei seguenti valori:
 - Eco → Abilita la funzione “Eco Mode”
 - Off → Disabilita la funzione “Eco Mode”
- e) Premere il tasto  per confermare i dati impostati.

4.3 FUNZIONE DELTA DI RIACCENSIONE

Delta di riaccensione: (nelle configurazioni installative 2, 3 e 4) è il numero di gradi al di sotto della temperatura di spegnimento oltre il quale la stufa si riaccende automaticamente. Ad esempio se la stufa è impostata per spegnersi a 20°C (Eco Mode attivo) e impostiamo un “Delta di riaccensione” di 4°C, la stufa si riaccenderà quando rileva una temperatura inferiore o uguale a 16°C.











Configurazione 2:

Per modificare il valore del delta di riaccensione:

- a) Agendo sui tasti freccia   portarsi sul menu setup  e premere il tasto .
- b) Selezionare la password “7” con il tasto  e confermare con il tasto .
- c) Selezionare il sottomenu [8] e confermare con il tasto .
- d) Lampeggerà il valore; modificarlo con i tasti  e  (0,5 ... 5,0°C);
- e) Premere il tasto  per confermare il dato impostato.

Configurazione 3 e 4:

Per modificare il valore del delta di riaccensione:

- a) Agendo sui tasti freccia   portarsi sul menu setup  e premere il tasto .
- b) Selezionare la password “7” con il tasto  e confermare con il tasto .
- c) Selezionare il sottomenu [8] e confermare con il tasto .
- d) Lampeggerà il valore; modificarlo con i tasti  e  (0 ... 40°C);
- e) Premere il tasto  per confermare il dato impostato.

4.4 FUNZIONE AUTONOMIA







Con questa funzione è possibile visualizzare le ore di autonomia, rimanenti prima di dover rifare il carico di pellet. Spostandosi con i tasti freccia sul simbolo  il display visualizzerà le ore di autonomia stimate prima di dover rifare il carico di pellet. L'autonomia viene calcolata in funzione dei parametri di lavoro impostati in quel momento sulla stufa. I valori stimati sono sufficientemente attendibili a patto che ad ogni rifornimento completo di pellet venga selezionato e confermato il valore “FULL”. Il valore “Lo” indica lo stato di riserva.

4.5 FUNZIONE RIFORMIMENTO

Con questa funzione è possibile comunicare alla stufa che si sta facendo il pieno di pellet nel serbatoio.

In questo modo, la stufa, in base ai parametri di funzionamento è in grado di stimare quante ore di autonomia restano prima di dover rifare il pieno di pellet al serbatoio.

Dopo aver riempito completamente il serbatoio di pellet:



- a) Spostarsi con i tasti freccia   sull'icona del combustibile  e dare invio .
 - b) Selezionare con i tasti  e  la dicitura “FULL” e dare invio .
- Se si vuole disabilitare tale funzione, selezionare “OFF” al posto di “FULL”.

4.6 RIACCENSIONE DOPO IL BLACK-OUT

In caso di interruzione di corrente elettrica, la stufa si riaccenderà automaticamente, verificando le condizioni di sicurezza, al ritorno dell'alimentazione.

4.7 FUNZIONE “BLOCCO TASTIERA”

Con questa funzione è possibile bloccare l'utilizzo del pannello comandi per evitare modifiche accidentali. Per abilitare/disabilitare tale funzione:

- Agendo sui tasti freccia ◀ ▶ portarsi sul menu setup  e premere il tasto ⏪;
- Selezionare la password “7” con il tasto + e confermare con il tasto ⏪;
- Selezionare il sottomenu [1 0] e confermare con il tasto ⏪.
- Impostare con i tasti + e - uno dei seguenti valori:
 - “Off” → Blocco tastiera disattivato
 - “Lo” → Resta abilitato solo il tasto di accensione/spegnimento 
 - “Hi” → Blocco tastiera attivato
- Premere il tasto ⏪ per confermare i dati impostati.

4.8 FUNZIONE ANTIGELO

Nelle configurazioni installative 2, 3 e 4 è possibile impostare una tempera minima al di sotto della quale la caldaia si accende (al di fuori delle fasce orarie impostate).

Configurazione 2:

Per modificare il valore della temperatura di “antigelo”:

- Agendo sui tasti freccia ◀ ▶ portarsi sul menu setup  e premere il tasto ⏪;
- Selezionare la password “7” con il tasto + e confermare con il tasto ⏪;
- Selezionare il sottomenu [9] e confermare con il tasto ⏪;
- Lampeggerà il valore; modificarlo con i tasti + e - (OFF; 3...20°C);
- Premere il tasto ⏪ per confermare il dato impostato.

Configurazione 3 e 4:

Per modificare il valore della temperatura di “antigelo”:

- Agendo sui tasti freccia ◀ ▶ portarsi sul menu setup  e premere il tasto ⏪;
- Selezionare la password “7” con il tasto + e confermare con il tasto ⏪;
- Selezionare il sottomenu [9] e confermare con il tasto ⏪;
- Lampeggerà il valore; modificarlo con i tasti + e - (OFF; 3...50°C);
- Premere il tasto ⏪ per confermare il dato impostato.

Se al punto d. si imposta il valore “OFF”, tale funzione viene disabilitata.

4.9 ATTIVAZIONE MANUALE DEL SISTEMA DI CARICAMENTO PELLETT

All'atto della prima accensione, o qualora il serbatoio risulti completamente vuoto, è possibile, una volta caricato il pellet nel serbatoio, attivare manualmente il sistema di caricamento in modo che il pellet ne riempia correttamente il circuito:









- Agendo sui tasti freccia ◀ ▶ portarsi sul menu setup  e premere il tasto ⏪;
- Selezionare la password “7” con il tasto + e confermare con il tasto ⏪;
- Selezionare il sottomenu [3 1] e confermare con il tasto ⏪;
- Selezionare la password “54”
- Tenere premuto il tasto ⏪ per attivare il sistema di caricamento manuale.



E' possibile attivare tale procedura solo a stufa spenta e completamente fredda.

4.10 ATTIVAZIONE MANUALE DEL SISTEMA MECCANICO DI PULIZIA BRACIERE

Qualora dovesse rendersi necessario attivare manualmente il sistema meccanico di pulizia del braciere, è possibile farlo attraverso la seguente procedura:

- a) Agendo sui tasti freccia   portarsi sul menu setup  e premere il tasto .
- b) Selezionare la password "7" con il tasto  e confermare con il tasto .
- c) Selezionare il sottomenu [32] e confermare con il tasto .
- d) Selezionare la password "54" e confermare con il tasto .
- e) Tenere premuto il tasto  per attivare un ciclo di pulizia del braciere.





E' possibile effettuare tale procedura solo a stufa spenta e completamente fredda.

5 GESTIONE DEGLI ALLARMI

5.1 DESCRIZIONE DEI MESSAGGI

Nel caso si verifichi un'anomalia nel funzionamento, viene attivata la seguente procedura:

- 1) allarme acustico (beep);
- 2) si illumina uno dei seguenti led di sistema:   ;
- 3) se l'anomalia riguarda un errore, la stufa (se è in funzionamento a pellet) si spegnerà.

La pressione prolungata del tasto "annulla"  consente la visualizzazione sul display del codice di errore:

CODICE ERRORE/AVVISO	DESCRIZIONE	POSSIBILI CAUSE	LED
E001	Pannello comandi difettoso	Difettosità del pannello comandi	
E002	Errore di comunicazione segnale telecomando	Difettosità del pannello comandi	
E004	Errore di comunicazione	Cavo di collegamento tra scheda e pannello comandi interrotto o staccato. Se appare durante il cambio di configurazione, ignorare tale errore	
E101	Acqua di mandata eccessivamente calda Errore di mancata accensione	Mancanza di pellet Qualità del pellet Sistema di accensione guasto Braciere sporco Problemi sull'impianto di riscaldamento Problemi sul circolatore	
E104	Sistema pulizia braciere bloccato	Un corpo estraneo impedisce il corretto funzionamento del sistema di pulizia della base del braciere.	
E105	Malfunzionamento sonda di temperatura	Sonda acqua di ritorno difettosa	
E106	Malfunzionamento sonda di temperatura	Sonda puffer / ambiente difettosa	
E107	Malfunzionamento sonda camera di combustione	Sonda in camera di combustione (posta sul retro della caldaia) scollegata o difettosa.	
E108	Errore di sicurezza termica	Problemi sull'impianto di riscaldamento Problemi sul circolatore Problemi di surriscaldamento del serbatoio pellet	
E109	Errore di pressione o sul controllo dell'aria	Sistema di evacuazione fumi sporco Guarnizioni di tenuta logorate Aria comburente insufficiente Problemi al sistema di controllo dell'aria comburente	
E110	Malfunzionamento sonda di temperatura	Sonda acqua di mandata difettosa	
E111	Malfunzionamento sonda fumi	Sonda temperatura fumi difettosa	
A002	Avviso di manutenzione programmata. (icone lampeggianti)	Periodicamente la stufa richiede che venga effettuata una manutenzione da parte di un tecnico specializzato	
A006	Avviso porta o cassetto aperti	Porta del focolare o cassetto cenere aperti	
A007	Malfunzionamento sensore di pressione. (icona lampeggiante)	Sensore di pressione o scheda guasti.	
----	Pulizia stufa	Camera di combustione, braciere o sistema di evacuazione dei fumi sporchi. Tubi rilevamento pressione staccati o ostruiti. Ingresso dell'aria comburente ostruito.	
----	Errore di mancata accensione	Pellet esaurito; Resistenza di accensione guasta; Guarnizioni consumate; Porta focolare aperta.	

5.2 RESET DEGLI ALLARMI

Dopo aver verificato il tipo messaggio è possibile resettare l'allarme premendo per qualche istante il tasto di accensione/spegnimento (⏻).

5.2.1 Casi particolari (a cura del Centro di Assistenza Tecnico):

Errore "E 108"

Nell'eventualità che il codice d'errore sia "E 108", può essere necessario riattivare i termostati a riarmo manuale (Fig. 5.1) svitando i tappi di protezione e premendo i pulsanti di riarmo.

Resettare l'allarme premendo per qualche istante il tasto di accensione/spegnimento (⏻).

A questo punto è possibile procedere con una nuova accensione.

Errore "E 104"

Nell'eventualità che il codice d'errore sia "E 104" procedere come segue:

- Provare a rimuovere eventuali corpi estranei dal braciere.
- Se questi sono rimasti bloccati è necessario procedere con l'Attivazione Manuale del Sistema Meccanico di pulizia del Braciere:

- Agendo sui tasti freccia (◀ ▶) portarsi sul menu setup (⚙) e premere il tasto (↵);
- Selezionare la password "7" con il tasto (+) e confermare con il tasto (↵);
- Selezionare il sottomenu [32] e confermare con il tasto (↵);
- Selezionare la password "54" e confermare con il tasto (↵);
- Tenere premuto per qualche secondo il tasto (↵) per attivare un ciclo di pulizia del braciere.

- Mentre è in atto la pulizia, premere per cinque secondi il microinterruttore (Fig. 5.2) avendo cura di tenere la porta del focolare chiusa.
- Riaprire la porta del focolare e verificare che il braciere sia stato liberato dai corpi estranei.
- Resettare l'allarme premendo per qualche istante il tasto di accensione/spegnimento (⏻).
- Attendere qualche minuto e procedere con una nuova accensione.



E' possibile effettuare tale procedura solo a stufa spenta e completamente fredda.

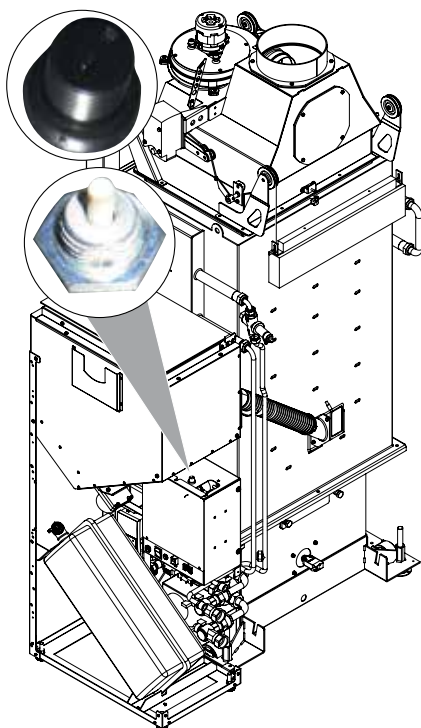

Fig. 5.1

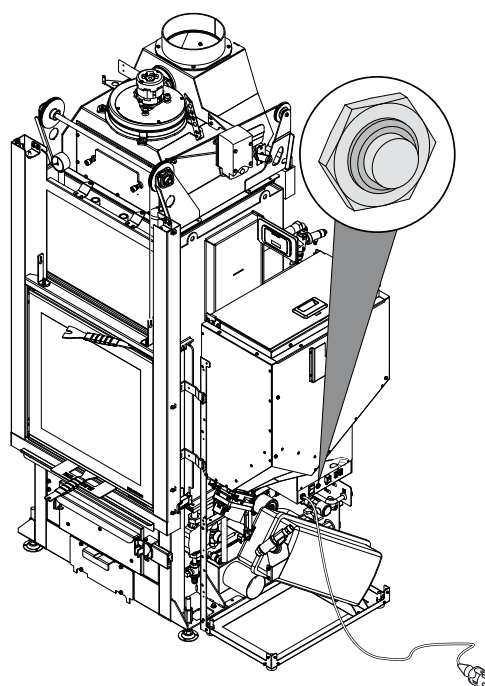

Fig. 5.2

INDEX

1 CONTROL PANEL

- 1.1 DESCRIPTION
- 1.2 USING THE CONTROL PANEL
- 1.3 OPERATING PARAMETERS

2 PRELIMINARY OPERATIONS

- 2.1 LOADING THE PELLETS
- 2.2 POWER SUPPLY
- 2.3 INITIAL SETTINGS

3 STOVE OPERATION

- 3.1 PREAMBLE
- 3.2 STARTING THE STOVE
- 3.3 MODIFYING THE PARAMETERS
- 3.4 CHANGING FUEL
- 3.5 SWITCHING OFF
- 3.6 OPERATION WITH ROOM THERMOSTAT (PELLET OPERATION ONLY)
- 3.7 OPERATION WITH ROOM PROBE ON THE BOILER
- 3.8 OPERATION IN COMBINATION WITH A STORAGE TANK

4 FUNCTIONS AVAILABLE

- 4.1 TIMER
- 4.2 "ECO MODE" SAVING FUNCTION (PELLET OPERATION ONLY)
- 4.3 RESTART DELTA FUNCTION
- 4.4 AUTONOMY FUNCTION
- 4.5 REFILL FUNCTION
- 4.6 RESTARTING AFTER A POWER FAILURE
- 4.7 "LOCK KEYPAD" FUNCTION
- 4.8 FROST PROTECTION FUNCTION
- 4.9 MANUAL ACTIVATION OF THE PELLET LOADING SYSTEM
- 4.10 MANUAL ACTIVATION OF THE MECHANICAL BRAZIER CLEANING SYSTEM

5 ALARM MANAGEMENT

- 5.1 DESCRIPTION OF MESSAGES
- 5.2 RESETTING ALARMS

1 CONTROL PANEL

Before reading this booklet, check the description of the stove provided in the “Product Booklet” enclosed.

1.1 DESCRIPTION

The control panel consists of:















- A) a top part with status LEDs and backlit icons that identify each function;
- B) LED display;
- C) ON button ;
- D) “Cancel” and display “error” button ;
- E) two arrow buttons to scroll between the various functions  ;
- F) two buttons  and  to set the operating parameters and access the submenus;
- G) an enter button  or confirm the parameter or the settings.









Fig. 1.1

 *All the buttons are capacitive, therefore the functions are activated without needing to press hard on the buttons, rather by just touching the surface.*

1.1.1 Status leds

ICON	WARNING	DESCRIPTION
	Pellets running out	Indicates that the pellet hopper needs to be refilled.
	Maintenance	Indicates the need to perform maintenance (this may also be displayed when repeatedly pressing the ON button)
	Service	Indicates an error
	Remote control receiver	It receives the inputs sent by the remote control (optional)
	Timer active	Indicates whether the timer function is active.
	Status LED (near the  button)	LED on steady: stove on and operating LED flashing: stove in the ignition stage or in standby LED off: stove off









1.1.2 Description of the menus

ICON	FUNCTION	DESCRIPTION	VALUES
	Power	Stove output setting	1..5
	Fan	This parameter is not enabled on water heating models	
	Temperature	Displays the probe* temperature reading and is used to set the desired temperature. *config.1: water probe; config.2: room probe; config. 3-4: external/tank probe.	config.1: 65..80 °C config.2: 10.. 48 °C config.3-4: 45..75 °C
	Fuel	[PELL] = Pellets [W] = Wood	
	Timer	Enables or disables the timer. When enabled, the icon  will be displayed steady (not flashing)	ON - OFF

ICON	FUNCTION	SUBMENU	DESCRIPTION	VALUES
	Setup	[1] Weekly timer	Assigns the programs (max 3) to the different days of the week	[d1] ... [d7]
		[2] Programs	Program setting menu	[P1] ... [P6]
		[3] Time / date	Time and date setting	
		[4] Hours remaining	Displays the number of hours remaining until recommended maintenance. When "Hi" is displayed, the remaining time exceeds 999 hours.	
		[5] System information	Displays the current software version	
		[6] Water temperature	It allows to set the desired temperature for the water supply (only in configuration 2).	60 ... 80°C
		[7] Eco function	Enables or disables Eco Mode, in which the stove automatically switches off and on based on room temperature (only in configuration 2).	OFF; Eco
		[8] Restart delta	Is the number of degrees centigrade below the switch-off temperature at which the stove switches on again automatically (except in configuration 1).	0,5 ... 5,0°C 0 ... 40°C
		[9] Frost protection temperature	Minimum temperature below which the stove switches on (except in configuration 1).	OFF; 3 ... 20 °C OFF; 3 ... 50 °C
		[10] Lock keypad	Disables the buttons on the keypad	OFF; Lo; Hi
		[11] Display brightness	Sets display brightness	OFF; 1 ... 5
		[12] Display mode	Sets how the data is displayed	OFF; 1 ... 4
		[13] Buzzer volume	Sets the buzzer volume	OFF; 1 ... 5
		[14] Type of pellets	Three different types of pellet can be set	1 ... 3
		[30] Installer menu	Sets/displays the stove configuration	PWD: "54"
		[31] Loading pellets	Manual activation of the pellet loading system	
[32] Brazier riddler	Manual activation of the mechanical brazier cleaning system			
[32] Pump power	Menu reserved for the service centre			
[40] Service menu	Menu reserved for the service centre			

Submenus [30] and [40] in the Setup menu are password-protected and reserved for service centre personnel.

1.2 USING THE CONTROL PANEL

- The arrow buttons   are used to scroll between the different menus that are highlighted.
- When selecting a given function, simply press the  button and then modify the values, again using the   buttons.
- Pressing the  button confirms the setting.
- In general all values that are flashing can be modified using the   buttons.
- The "cancel" button  is used to cancel any changes; pressing and holding the button displays any active alarm or error codes.







1.3 OPERATING PARAMETERS

Stove operation is determined by the Power level and Temperature parameters set by the user.

1.3.1 setting the power level







The power level defines the amount of heat produced by the stove and consequently directly affects fuel consumption.

To change the power level use the   buttons to go to the power menu 

- a) Use the   buttons to scroll the submenu
- b) Select submenu "1" and confirm by pressing  .
- c) The power level value will flash; set the value using the   (buttons (1 minimum,...5 maximum)
- d) Press  to confirm the settings.

1.3.2 Setting the temperature

Different temperature values can be set depending on the boiler's configuration:

- a) Use the   buttons to go to the temperature menu  and press  ;
- b) The current value will flash; change it using the   buttons
- c) Press  to confirm the settings.

Water temperature (configuration 1 only): setting this value changes the desired hot water outlet temperature.

Room temperature (configuration 2 only): setting this value defines the desired room temperature, read directly by a probe fitted on the boiler.

Storage temperature (configurations 3 and 4 only): identifies the minimum desired temperature inside the storage tank.

2 PRELIMINARY OPERATIONS









2.1 LOADING THE PELLETS

The first operation to be performed before starting the appliance is to fill the hopper with fuel (pellets).

The pellets are loaded into in the hopper using a scoop.

Do not empty the sack directly into the hopper so as to avoid loading sawdust or other foreign bodies that may affect proper stove operation and avoid spilling pellets outside of the hopper.

 Make sure the hopper lid is well closed again after having loaded the pellets.

 To use the “autonomy” function, press the arrow buttons   to move to the fuel icon  and press enter . Use the   buttons to select “FULL” and then press enter .

To disable the function, rather than “FULL” select “OFF”.

2.2 POWER SUPPLY

Plug the stove into the mains power supply, move the power switch (Fig. 2.1- A) to position “I”. If the connections are correct the stove will emit a series of intermittent beeps, the display will come on.

 **Make sure not to touch the control panel while plugging the stove into the power supply.**

 If not using the appliance for an extended period, the switch should be moved to position OFF (0).



























 **The stove will only operate properly if it has the proper electrical power supply. Do not operate the stove without electrical power!**

2.3 INITIAL SETTINGS

The language, current date and time need to be set before using the stove.

2.3.1 Time and Date setting

To set the date:

- a) Use the   buttons to go to the setup menu  and press .
- b) Use the  button to select the password “7” and then press  to confirm;
- c) Use the  button to scroll to and select submenu [3] and press  to confirm;
- d) The hour value will flash; set the value using the   buttons and press .
- e) The minutes value will flash; set the value using the   buttons and press .
- f) The day value will flash; set the value using the   buttons and press .
- g) The month value will flash; set the value using the   buttons and press .
- h) The year value will flash; set the value using the   buttons and press .
- i) The current weekday value will flash (Monday = 1... Sunday = 7); set the value using the   buttons;
- j) Press  to confirm the settings.

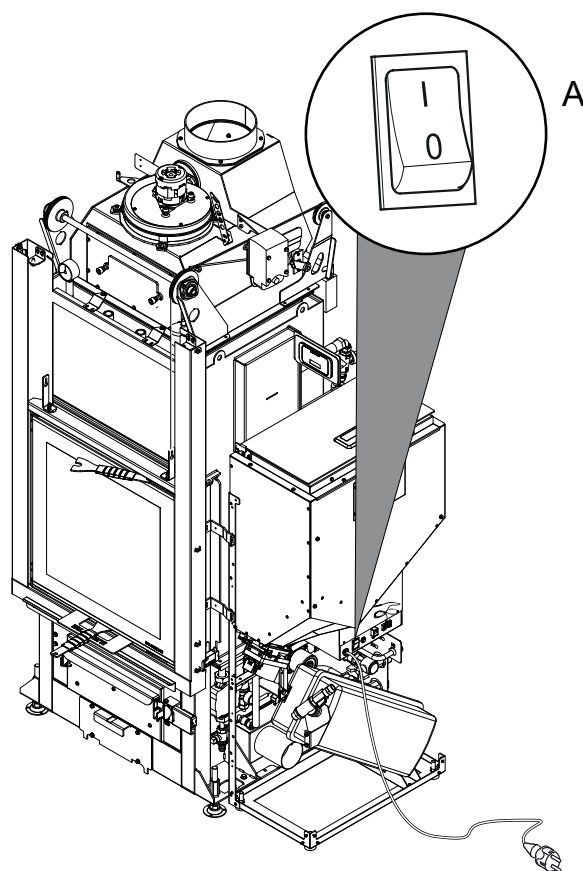













Fig. 2.1













2.3.2 Setting the display brightness

Display brightness when in standby mode can be set.

- Use the arrow buttons   to go to the setup menu  and then press .
- Use the  button to select the password "7" and then press  to confirm;
- Use the  button to scroll to and select submenu [1 1] and press  to confirm;
- Set the desired brightness (OFF, 1 ... 5) using the   buttons and press  to confirm.











2.3.3 Setting the display mode

The data shown on the display when this is in standby mode can be set.

- Use the arrow buttons   to go to the setup menu  and then press .
- Use the  button to select the password "7" and then press  to confirm;
- Use the  button to scroll to and select submenu [1 2] and press  to confirm;
- Set one of the following values using the  and  buttons:
 - "OFF" • The display remains on the last operation set by the user;
 - "1" • All operating parameters are displayed cyclically;
 - "2" • The room probe temperature is shown
 - "3" • The current time is shown
 - "4" • The operating autonomy in hours before having to refill the hopper is shown, If the function "filling" has been activated (in wood-fired operation, the  symbol will be displayed).
- Press  to confirm the settings.











2.3.4 Setting the volume

The volume of the buzzer can be set based on requirements:

- Use the arrow buttons   to go to the setup menu  and then press .
- Use the  button to select the password "7" and then press  to confirm;
- Use the  button to scroll to and select submenu [1 3] and press  to confirm;
- Set the desired volume (OFF, 1 to 5) using the   buttons and press  to confirm.

2.3.5 Setting the type of pellets

The type of pellets used can be set:

- Use the arrow buttons   to go to the setup menu  and then press .
- Use the  button to select the password "7" and then press  to confirm;
- Use the  button to scroll to and select submenu [1 4] and press  to confirm;
- Set one of the following values using the  and  buttons:
 - "1" • Standard pellet (En Plus)
 - "2" • Long pellet
 - "3" • Small pellet
- Press  to confirm the settings.

3 STOVE OPERATION

3.1 PREAMBLE

The stove can start combustion automatically (pellets only) or manually (wood only).

In pellet operation, the stove can also be programmed to start at a set time.

When off, the stove is ready to operate in wood-fired mode, as indicated by the **UU** symbol (fig.3.1).

Do not touch painted parts when starting the stove the first few times, to avoid damaging the paintwork.

! When the stove is started the first time, unpleasant odours or smoke may be generated, caused by evaporation or drying of certain materials used. This phenomenon will gradually disappear.

! **The room should be well ventilated when starting the stove the first few times.**

! **When opening the firebox door, never leave it open too long, otherwise the door sensor will set off the open door signal (audible alarm).**

! **The stove will only operate properly if it has the proper electrical power supply. Do not operate the stove without electrical power!**

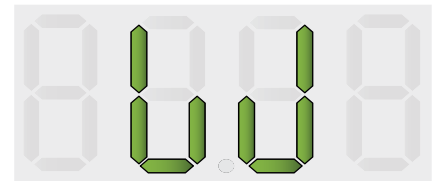

Fig. 3.1

3.2 STARTING THE STOVE

3.2.1 Manual ignition in wood-fired mode

Sequence of operations:

1. use the disposition handle and to push upward (Fig. 3.2);
2. place small pieces of wood on the bottom of the firebox, making sure not to obstruct the pellet feed tube;
3. place a natural fire-igniter on the stack, add thin sticks of wood by crossing them and light the fire-igniter from above;
4. close the door by pushing it downwards until it locks.

The stove automatically adjusts the combustion air intake.

! **DANGER**

Never use alcohol, petrol, kerosene or other liquid fuels to ignite the fire.

Keep such substances away from the fire.

Never use petroleum- or chemical-based fire starter blocks.

One exclusively ecological fire starter blocks.

The wood charge should be made when the previous load was reduced to amber.

Do not overload the wood stove; follow the hourly fuel consumption indicated in the technical specifications.

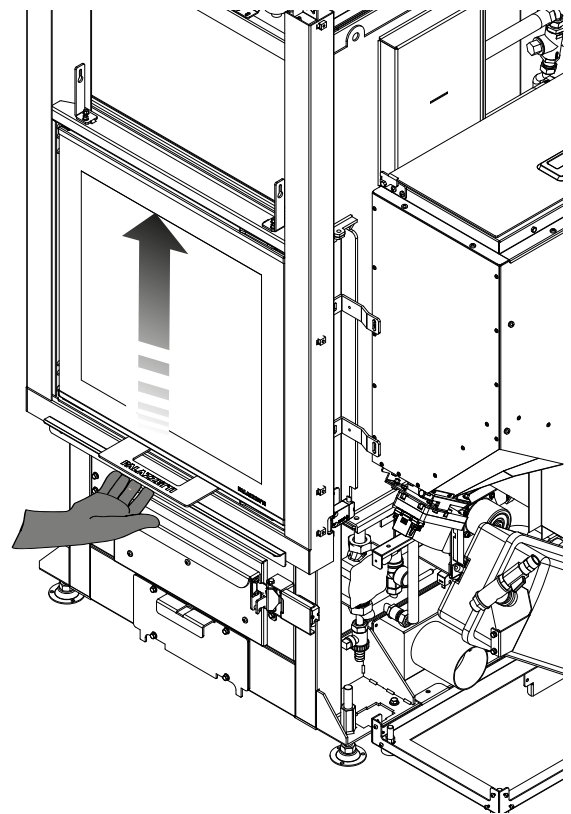

Fig. 3.2

If a pellet ignition program has been set during wood-fired operation (🔥 mode), the stove will not switch automatically to pellet mode until all the wood in the firebox has finished burning. When the wood has finished burning, an automatic burn pot cleaning cycle is performed, and if the program is still active for the current time band, the stove will start in pellet operation.

3.2.2 Automatic ignition in pellet mode

Make sure there is a sufficient quantity of pellets in the pellet hopper.

To start the stove, hold the  button for several seconds.

The flame icon will start flashing during the ignition stage, until remaining on steady when the stove has started.

! Automatic ignition: the stove comes with an automatic device that starts the pellet stove without using other traditional fire lighters.

3.3 MODIFYING THE OPERATING PARAMETERS

The stove operating parameters can be modified as described in paragraph 1.3.



 The values set will be retained until next modified, even when the stove is switched off or unplugged from the power supply.



3.4 CHANGING FUEL

The stove allows the possibility to change the type of fuel used (wood/pellet) while the stove is already operating.

3.4.1 Switching from wood to pellets

To switch to automatic pellet operation when operating on wood fuel, simply hold the  button for a few seconds:

1. the ignition LED  will start flashing
2. when the wood has finished burning, the stove will run a cleaning cycle
3. after cleaning, the stove switches to pellet operation and the ignition LED  comes on steady.

 If the pellet function is on, press the  key for a few seconds to disable it (the power LED  will no longer flash and the work "OFF" will appear).

3.4.2 Switching from pellets to wood

To switch to wood-fired operation when in pellet mode, simply:

1. open the door
2. load some logs of wood in the burn pot, making sure not to obstruct the pellet feed tube
3. close the door again

If enough wood has been loaded, after a few minutes the stove will automatically switch to wood-fired operation, and therefore more fuel will need to be loaded manually to continue combustion.

The symbols [PELL]= will appear on the display of the fuel menu when the stove is in pellet position and [W]= when is in wood position.

The display will show the  symbol on the fuel menu.

 When loading wood, the door needs to stay open for at least 3 seconds, so that the stove can recognise the operation.

3.5 SWITCHING OFF

3.5.1 Switching off in wood-fired mode

To switch the stove off in wood-fired operating mode, simply stop loading fuel into the firebox.

When the wood has finished burning, the stove will perform an automatic burn pot cleaning cycle.

3.5.2 Switching off in pellet mode

To switch the stove off in pellet operating mode, hold the  button for a few seconds; the flame icon will switch off.

When the pellets have finished burning, the stove will perform an automatic burn pot cleaning cycle.

 The stove should only be switched off following the procedure described above. Never switch the stove off by unplugging it from the power supply.

3.6 OPERATION WITH ROOM THERMOSTAT (PELLET OPERATION ONLY)

When the stove is controlled by an external thermostat (or timer thermostat), the installer must have set configuration 1.

In this configuration the stove switches off when reaching the external thermostat setting or alternatively modulates output (that is, the stove attempts to maintain the desired temperature while minimising fuel consumption) when reaching the set water temperature.

The stove switches on again automatically when the temperature falls below the value set on the external thermostat (circuit closed).



On first ignition, or if the stove has been switched off manually (⏻ button), the stove needs to be started directly from the control panel.

The stove will go off automatically even in the case the water temperature keeps growing notwithstanding the modulation mode. In this case the stove will ignite only if the difference between the selected and actual temperature is over 20°C.

Therefore, if you choose this configuration, we suggest that you select a high water temperature (e.g.. 70°C).

3.7 OPERATION WITH ROOM PROBE ON THE BOILER

The boiler can be switched on/off manually or in programmed mode.

In this type of configuration, the boiler modulates output according to the room temperature read by the probe on the boiler (that is, the boiler attempts to maintain the desired temperature while minimising fuel consumption).

If the user has enabled the “Eco-mode” function under submenu [7] of the setup menu ⚙️, the boiler rather than modulating its output, switches off when reaching the set temperature, and switches on again when the room temperature falls below the delta set in submenu [8] of the setup menu ⚙️.

The desired room temperature can be set in temperature menu 🌡️.

Submenu [6] of the setup menu ⚙️ can be used to set the desired water outlet temperature (the best temperature for the heating system in question should be suggested by the heating system installer).

3.8 OPERATION IN COMBINATION WITH A STORAGE TANK

For operation in combination with a storage tank, the installer will have set configuration 3 or 4, depending on whether the storage tank is with or without a coil inside.

The boiler is controlled based on the temperature read by the probe in the storage tank.

When reaching the storage tank temperature set in the temperature menu 🌡️ the boiler switches off, and switches on again if the temperature falls below the delta set in submenu [8] of the setup menu ⚙️.

The frost protection function can also be set in this configuration.

4 FUNCTIONS AVAILABLE

4.1 TIMER

It's possible to set, enable and assign to the various days of the week, customised programs for automatically switching the stove on and off.

























Up to six customised programs can be set.

For each program, the following can be set: on time, off time and desired temperature.

Up to three programs can be assigned for each day of the week.



















The days of the week are identified by numbers: Monday = "d1", Tuesday = "d2";...; Sunday = "d7" ..

4.1.1 Setting the programs







- Use the arrow buttons   to go to the setup menu  and then press .
- Use the  button to select the password "7" and then press  to confirm;
- Select submenu **[2]** and confirm by pressing .
- Use the   buttons to scroll the programs P1...P6;
- The on hours value will flash; set the value using the   buttons and press .
- The minutes value will flash; set the value using the   buttons and press .
- The off hours value will flash; set the value using the   buttons and press .
- The minutes value will flash; set the value using the   buttons and press .
- The desired temperature value will flash; set the value using the   buttons and press .
- Press  to confirm the settings.

4.1.2 Assigning the programs to specific days

This function can be used to assign up to three different programs to a certain day.

- Use the arrow buttons   to go to the setup menu  and then press .
- Use the  button to select the password "7" and then press  to confirm;
- Select submenu **[1]** and confirm by pressing .
- Use the   buttons to choose the day [d1]...[d7] to assign the programs to
- Select this using the .
- The value of the first program to assign will flash: P1...P6 or "OFF" to disable;
- Set the value using the   buttons and press .
- The value of the second program to assign will flash: P1...P6 or "OFF" to disable;
- Set the value using the   buttons and press .
- The value of the third program to assign will flash: P1...P6 or "OFF" to disable;
- Set the value using the   buttons and press  to confirm the settings.

4.1.3 Enabling/disabling the timer











- Use the arrow buttons   to go to the Timer menu .
- Select this using the .
- Use the   buttons to scroll and select: "ON" to enable the timer or "OFF" to disable it;
- Press  to confirm the selection.

When the timer is enabled, the  icon will be on steady, indicating that the timer is active.

4.2 “ECO MODE” SAVING FUNCTION (PELLET OPERATION ONLY)

Enabling this function means that the stove switches off when reaching the desired room temperature. If this function is not enabled, the stove modulates operation so as to maintain the desired temperature while consuming the least amount of fuel possible. The “Eco Mode” function is only available in configuration 2.

To enable/disable the function:











- Use the arrow buttons   to go to the setup menu  and then press .
- Use the  button to select the password “7” and then press  to confirm;
- Select submenu [7] and confirm by pressing .
- Set one of the following values using the   buttons:
Eco → “Eco Mode” function enabled
Off → “Eco Mode” function disabled
- Press  to confirm the settings.

4.3 RESTART DELTA FUNCTION

Restart delta (configurations 2, 3 and 4) is the number of degrees centigrade below the switch-off temperature at which the stove switches on again automatically. For example, if the stove is set to switch off at 20°C (Eco Mode active) and “Restart delta” is set to 4°C, the stove will switch on again when the temperature measured is less than or equal to 16°C.











Configuration 2:

To set the restart delta value:

- Use the arrow buttons   to go to the setup menu  and then press .
- Use the  button to select the password “7” and then press  to confirm;;
- Select submenu [8] and press  to confirm;
- The value will flash; change it using the  and  buttons (0,5 ... 5,0°C);
- Press the  button to confirm the set value.

Configuration 3 and 4:

To set the restart delta value:

- Use the arrow buttons   to go to the setup menu  and then press .
- Use the  button to select the password “7” and then press  to confirm;;
- Select submenu [8] and press  to confirm;
- The value will flash; change it using the  and  buttons (0 ... 40°C);
- Press the  button to confirm the set value.

4.4 AUTONOMY FUNCTION

This function is used to display the number of hours of operating autonomy remaining before having to refill with pellets. Use the arrow buttons to move to the  symbol and display the estimated operating hours before having to refill with pellets. The autonomy is calculated according to the operating parameters set at that moment on the stove.

The estimated values are quite reliable, as long “FULL” is selected and confirmed whenever refilling the stove completely. “Lo” indicates the reserve fuel level.

4.5 REFILL FUNCTION

This function is used to tell the stove that the hopper is being filled with pellets.

In this way, the stove can estimate, based on the operating parameters, how many hours of autonomy remain before having to fill the hopper with pellets again.

After having completely filled the pellet hopper:

- a) Use the arrow buttons to move to the fuel icon and press enter .
 - b) Use the buttons to select "FULL" and press enter .
- To disable this function, select "OFF" instead of "FULL".

4.6 RESTARTING AFTER A POWER FAILURE

In the event of power failures, the stove will switch back on automatically, checking the safety conditions, when power returns.

4.7 "LOCK KEYPAD" FUNCTION

This function is used to disable the use of the control panel and avoid accidental modifications.

To enable/disable the function:

- a) Use the arrow buttons to go to the setup menu and then press .
- b) Use the button to select the password "7" and then press to confirm;
- c) Select submenu [10] and confirm by pressing .
- d) Use the buttons to set one of the following values:
 - "Off" Lock keypad disabled
 - "Lo" Only the on/off button is enabled
 - "Hi" Lock keypad enabled
- e) Press to confirm the settings.

4.8 FROST PROTECTION FUNCTION

In configurations 2, 3 and 4 a minimum temperature can be set below which the boiler will switch on (outside of the set time bands).

Configuration 2:

To set the "frost protection" temperature:

- a) Use the arrow buttons to go to the setup menu and then press .
- b) Use the button to select the password "7" and then press to confirm;
- c) Select submenu [9] and confirm by pressing .
- d) The value will flash; change it using the buttons (OFF; 3...20°C);
- e) Press to confirm the settings.

Configuration 3 and 4:

To set the "frost protection" temperature:

- a) Use the arrow buttons to go to the setup menu and then press .
- b) Use the button to select the password "7" and then press to confirm;
- c) Select submenu [9] and confirm by pressing .
- d) The value will flash; change it using the buttons (OFF; 3...50°C);
- e) Press to confirm the settings.

Setting the value to "OFF" in step d disables the function.

4.9 MANUAL ACTIVATION OF THE PELLET LOADING SYSTEM

When you first start up the stove, or if the tank is completely empty, first load pellets into the tank, then manually activate the loading system to charge the circuit with pellets:









- a) Use the arrow keys to enter the setup menu and press key .
- b) Enter the password "7" with key and confirm with key .
- c) Select submenu [31] and confirm with key .
- d) Enter password "54"
- e) Hold down key to start the manual loading system.



You can only run this procedure when the stove is off and completely cold.

4.10 MANUAL ACTIVATION OF THE MECHANICAL BRAZIER CLEANING SYSTEM

To manually activate the mechanical brazier cleaning system, proceed as follows:

- a) Use the arrow keys   to enter the setup menu  and press key ;
- b) Enter the password "7" with key  and confirm with key ;
- c) Select submenu [32] and confirm with key ;
- d) Enter password "54" and confirm with key ;
- e) Hold down key  to start the manual loading system.





Only do this when the stove is off and completely cold.



5 ALARM MANAGEMENT

5.1 DESCRIPTION OF MESSAGES

If a malfunction occurs, the following procedure is activated:

- 1) audible alarm (beep);
- 2) one of the following system LEDs come on:   ;
- 3) if the problem concerns an error, the stove (if it is operating burning pellets) will switch off.

Pressing and holding the “cancel” button  shows the error code on the display:

ERROR/ WARNING CODE	DESCRIPTION	POSSIBLE CAUSES	LED
E001	Faulty control panel	Control panel fault	
E002	Remote control signal communication error	Control panel fault	
E004	Communication error	Connection cable between board and control panel interrupted or detached. If this appears when changing configuration, ignore the error	
E101	Outlet water temperature too high Failed ignition error	No pellets Pellet quality Faulty ignition system Burn pot dirty Problems with the heating system Problems with the pump	
E104	Brazier cleaning system jammed	A foreign body is stopping the brazier cleaning system from operating.	  
E105	Temperature probe malfunction	Faulty return water temperature probe	
E106	Temperature probe malfunction	Faulty buffer-tank/room temperature probe	
E107	Combustion chamber probe malfunction	Faulty combustion chamber probe	
E108	Thermal cutout error	Problems with the heating system Problems with the pump Problems with overheating in the pellet hopper	
E109	Pressure error or air control error	Flue system dirty Seals worn Insufficient combustion air Combustion air control system fault	
E110	Temperature probe malfunction	Faulty outlet water temperature probe	
E111	Flue gas temperature probe malfunction	Faulty flue gas temperature probe	
A002	Scheduled maintenance warning (<i>icons flashing</i>)	The stove periodically requires maintenance to be performed by a qualified technician	 
A006	<i>Warning - door or drawer open</i>	The firebox door or ash drawer is open	  
A007	Pressure sensor malfunction (<i>icon flashing</i>)	Pressure sensor or board fault.	
----	Clean stove	Combustion chamber, burn pot or flue gas exhaust system dirty. Pressure measuring tubes detached or blocked. Combustion air intake blocked.	
----	Failed ignition error	No pellets; Faulty ignition heater; Worn gaskets; Firebox open.	

5.2 RESETTING ALARMS

After having checked the type of message, the alarm can be reset by pressing the on/off button  for a few moments.

5.2.1 Special cases (Technical Service Centre only):

Error “E 108”











If the error code is “E 108”, it may be necessary to re-arm the manual reset thermostats (Fig. 5.1) by unscrewing the caps and pressing the reset buttons.

Reset the alarm by holding down the on/off button for a few seconds .

You can now start up the stove again.

Error “E 104”

If the error code is “E 104” proceed as follows:

- Remove any foreign bodies inside the brazier.
- If this is not possible, run the manual mechanical brazier cleaning procedure:
 - a) Use the arrow keys   to enter the setup menu  and press key .
 - b) Enter the password “7” with key  and confirm with key .
 - c) Select submenu [32] and confirm with key .
 - d) Enter password “54” and confirm with key .
 - e) Press and hold the  key for a few seconds to activate a burn pot cleaning cycle.
- While cleaning is in progress, hold the microswitch (Fig. 5.2) down for five seconds, making sure to keep the brazier door closed.
- Re-open the brazier door and check that the foreign bodies have been cleared out.
- Reset the alarm by holding down the on/off button for a few seconds .
- Wait a few minutes, then start up the stove again.



Only do this when the stove is off and completely cold.

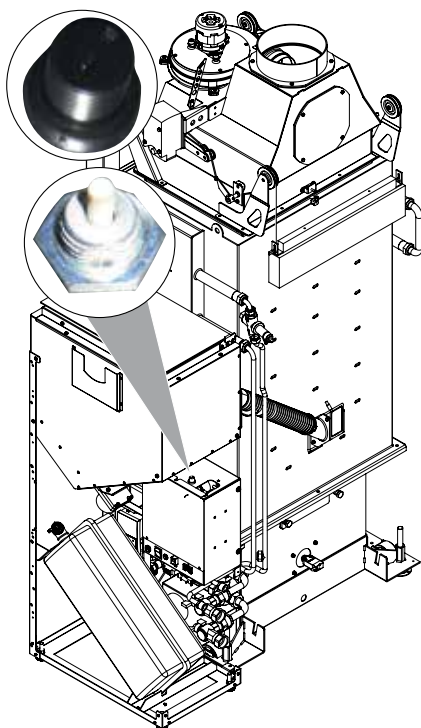

Fig. 5.1

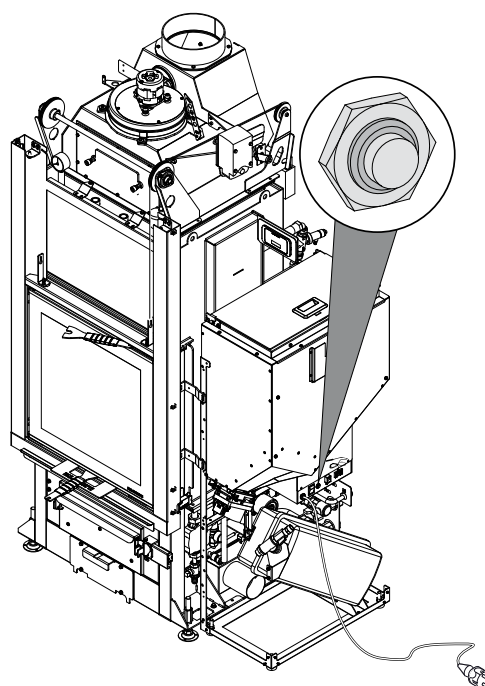

Fig. 5.2

INHALT

1 BEDIENFELD

- 1.1 BESCHREIBUNG
- 1.2 BENUTZUNG DES BEDIENPANELS
- 1.3 BETRIEBSPARAMETER

2 ERSTE SCHRITTE

- 2.1 PELLETZUFÜHRUNG
- 2.2 STROMVERSORGUNG
- 2.3 ANFÄNGLICHE EINSTELLUNGEN

3 GEBRAUCH DES OFENS

- 3.1 VORWORT
- 3.2 EINSCHALTUNG
- 3.3 ÄNDERUNG DER PARAMETER
- 3.4 WECHSEL DES BRENNSTOFFS
- 3.5 AUSSCHALTUNG
- 3.6 BETRIEB MIT RAUMTHERMOSTAT (NUR BEI PELLETBETRIEB)
- 3.7 BETRIEB MIT RAUMTEMPERATURFÜHLERAMOFEN
- 3.8 BETRIEB IN KOMBINATION MIT EINEM SPEICHER

4 VERFÜGBARE FUNKTIONEN

- 4.1 TIMER
- 4.2 SPARFUNKTION "ECO MODE"(NUR BEI PELLETBETRIEB)
- 4.3 FUNKTION EINSCHALTDIFFERENZ
- 4.4 FUNKTION BETRIEBSDAUER
- 4.5 NACHFÜLLFUNKTION
- 4.6 WIEDEREINSCHALTEN NACH STROMAUSFALL
- 4.7 FUNKTION „TASTATURSPERRE“
- 4.8 FROSTSCHUTZFUNKTION
- 4.9 MANUELLE AKTIVIERUNG DES PELLETNACHFÜLLSYSTEMS
- 4.10 MANUELLE AKTIVIERUNG DES MECHANISCHEN KOHLENBECKENREINIGUNGSSYSTEMS

5 VERWALTUNG DER ALARMMELDUNGEN

- 5.1 BESCHREIBUNG DER MELDUNGEN
- 5.2 ZURÜCKSETZEN DER ALARME

1 BEDIENFELD

Bevor Sie im Handbuch weiterlesen, bitten wir Sie, die im beiliegenden „Produktheft“ enthaltene Beschreibung des Ofens nachzuschlagen.

1.1 BESCHREIBUNG

Bestandteile des Bedienpanels:







- A) obere Anzeigeleiste mit den Status-LEDs und den hinterleuchteten Symbolen der einzelnen Funktionen;
- B) LED-Display;
- C) inschalttaste (⏻);
- D) Taste „Abbrechen“ und „Fehleranzeige“ (⏮);
- E) zwei Pfeiltasten für die Navigation durch die verschiedenen Funktionen (⏪ ⏩);
- F) zwei Tasten (+) und (-) zum Bearbeiten der Betriebsparameter und zum Aufrufen der Untermenüs;
- G) eine Eingabetaste (↵) für die Bestätigung des Parameters oder der Auswahl.









Fig. 1.1

 *Alle Tasten sind kapazitiv, d.h. zur Aktivierung müssen sie nicht gedrückt, sondern lediglich berührt werden.*

1.1.1 Status led

SYMBOL	MELDUNG	BESCHREIBUNG
	Pellets fast leer	Der Pelletbehälter muss gefüllt werden.
	Wartung	Ein Wartungseingriff muss durchgeführt werden (kann auch dann erscheinen, wenn die Taste ON wiederholt gedrückt wird)
	Service	Zeigt das Vorliegen eines Fehlers an
	Empfänger der Fernbedienung	Es nimmt die Befehle von dem Fernbedienung an (optional)
	Timer aktiv	Zeigt an, ob die Funktion Timer aktiv ist.
	Status-LED(vneben der Taste (⏻))	Led mit Dauerlicht: Ofen eingeschaltet und in Betrieb Led blinkt: Ofen in Einschaltphase oder Standby Led erloschen: Ofen ausgeschaltet

1.1.2 Beschreibung der menüs

SYMBOL	FUNKTION	BESCHREIBUNG	WERTE
	Leistung	Einstellung der Betriebsstufe	1..5
	Lüftung	Bei den wassergeführten Modellen ist dieser Parameter nicht aktiviert	
	Temperatur	Es zeigt die Temperatur die bei der Sonde* gelesen wird und erlaubt man die gewünschte Temperatur einzustellen. *Konfiguration1: Vorlaufsonde; Konfig.2: Raum-Konfiguration; Konfiguration 3-4: Externe Sonde/Puffer Sonde.	Konfig.1: 65..80 °C Konfig.2: 10.. 48 °C Konfig.3-4: 45..75 °C
	Brennstoff	[PELL] = Pellets [W] = Holz	
	Timer	Timer aktivieren oder deaktivieren. Wenn er aktiviert ist, wird das Symbol dauerhaft angezeigt 	ON - OFF

SYMBOL	FUNKTION	UNTERMENÜ	BESCHREIBUNG	WERTE	
	Setup	[1]	Wochentimer	Zuweisung der Programme (max. 3) an die verschiedenen Wochentage	[d1] ... [d7]
		[2]	Programme	Menü der Programmeinstellung	[P1] ... [P6]
		[3]	Uhrzeit / Datum	Uhrzeit und Datum einstellen	
		[4]	Verbleibende Stunden	Anzeige der verbleibenden Stunden bis zur empfohlenen Wartung. Mit dem Wert "Hi" wird eine Zahl über 999 Stunden angegeben.	
		[5]	Systeminformationen	Anzeige der aktuellen Software-Version	
		[6]	Wassertemperatur	Hier können Sie die gewünschte Temperatur für das Wasser gesetzt (nur in der Konfiguration 2).	60 ... 80°C
		[7]	Funktion Eco	Schaltet den Modus Eco frei bzw. sperrt ihn, wodurch das Ausschalten und Wiedereinschalten anhand der Raumtemperatur automatisch erfolgt (Nur in der Konfiguration 2).	OFF; Eco
		[8]	Einschaltdifferenz	Unterhalb der Ausschalttemperatur liegender Wert in Grad Celsius, bei dessen Überschreitung der Ofen automatisch wieder eingeschaltet wird (Außer in Konfiguration 1).	0,5 ... 5,0°C 0 ... 40°C
		[9]	Frostschutztemperatur	Mindesttemperatur, bei deren Unterschreitung der Ofen eingeschaltet wird (Außer in Konfiguration 1).	OFF; 3 ... 20°C OFF; 3 ... 50°C
		[10]	Tastatursperre	Modus Tastatursperre einstellen	OFF; Lo; Hi
		[11]	Displayhelligkeit	Helligkeitsgrad des Displays einstellen	OFF; 1 ... 5
		[12]	Displaymodus	Anzeigemodus der Daten einstellen	OFF; 1 ... 4
		[13]	Summerlautstärke	Lautstärke des Signaltons einstellen	OFF; 1 ... 5
		[14]	Pelletart	Es können 3 verschiedene Pelletarten eingestellt werden	1 ... 3
		[30]	Installateur-Menü	Ofenkonfiguration bearbeiten/anzeigen	PWD: "54"
		[31]	Pelletnachfüllung	Manuelle Aktivierung des Pelletnachfüllsystems	
		[32]	Kohlenbeckenrüttler	Manuelle Aktivierung des mechanischen Kohlenbeckenreinigungssystems	
[33]	Versorgung Pumpe	Dem Kundendienst vorbehaltenes Menü			
[40]	Service-Menü	Dem Kundendienst vorbehaltenes Menü			

Die Untermenüs [30] und [40] des Menüs Setup sind passwortgeschützt und sind ausschließlich dem Kundendienst vorbehalten.

1.2 BENUTZUNG DES BEDIENPANELS

- Mit den Pfeiltasten ◀ ▶ wird der Cursor zwischen den verschiedenen, jeweils aufleuchtenden Menüs bewegt.
- Innerhalb einer bestimmten Funktion einfach die Taste ↵ betätigen und mit den Tasten + - die Werte ändern.
- Mit der nochmaligen Betätigung der Taste ↵ wird die Änderung bestätigt.
- Im Allgemeinen können zu diesem Zeitpunkt alle blinkenden Werte mit den Tasten + - geändert werden.
- Mit der Taste "abbrechen" ⏪ kann die Änderung abgebrochen werden; durch anhaltendes Drücken dieser Taste wird ein eventueller Alarm- oder Fehlercode auf dem Display angezeigt.

1.3 BETRIEBSPARAMETER

Der Ofenbetrieb wird von den benutzerdefinierten Leistungs- und Temperaturparametern bestimmt.

1.3.1 Leistungsstufe ändern

Die Leistung definiert die vom Ofen erzeugte Wärmemenge und hat daher direkten Einfluss auf den Verbrauch. Zur Änderung der Leistung den Cursor mit den Tasten ◀ ▶ auf das Menü Leistung 🔥 setzen.

- a) Mit den Tasten + - durch das Untermenü blättern.
- b) Das Untermenü "1" wählen und mit der Taste ↵ bestätigen.
- c) Der Leistungswert blinkt; den Wert mit den Tasten + - ändern (1 kleinste Stufe,...,5 Höchststufe).
- d) Die eingegebenen Daten mit der Taste ↵ bestätigen.

1.3.2 Temperatur ändern

Je nach Installationskonfiguration des Ofens können verschiedene Temperaturwerte geändert werden:

- a) Mit den Tasten ◀ ▶ das Menü Temperatur 🔒 aufrufen und die Taste ↵ drücken;
- b) Der aktuelle Wert blinkt; Wert mit den Tasten + - ändern;
- c) Den eingegebenen Wert mit der Taste ↵ bestätigen.

Wassertemperatur (nur Installationskonfigurationen 1): Durch Ändern dieses Wertes wird die gewünschte Vorlauftemperatur des Warmwassers durch den Ofen geändert.

Raumtemperatur (nur in der Installationskonfiguration 2): Durch Ändern dieses Wertes wird die Temperatur festgelegt, die im Raum erreicht werden soll, und die direkt von einem am Ofen eingebauten Temperaturfühler gemessen wird.

Speichertemperatur (nur Installationskonfigurationen 3 und 4): Dies ist die Mindesttemperatur, die im Speicher gehalten werden soll.

2 ERSTE SCHRITTE

2.1 PELLETZUFÜHRUNG

Bevor das Gerät eingeschaltet wird, muss als erstes der Brennstoffbehälter (Pellets) gefüllt werden.

Schütten Sie die Pellets nicht direkt aus dem Sack in den Behälter, um nicht versehentlich Sägemehl oder andere Fremdkörper einzufüllen, die den einwandfreien Betrieb des Ofens beeinträchtigen könnten, und um keine Pellets außerhalb des Behälters zu verstreuen.

☞ Nach dem Einfüllen der Pellets muss die Abdeckung des Brennstoffbehälters wieder gut verschlossen werden.

☞ Wenn die Funktion „Betriebsdauer“ genutzt werden soll, mit den Pfeiltasten ◀ ▶ nun das Symbol Brennstoff  anwählen und Enter ↵ drücken. Mit den Tasten + - die Option „FULL“ anwählen und Enter ↵ drücken

Wenn diese Funktion gesperrt werden soll, anstatt „FULL“ die Option „OFF“ anwählen.

2.2 STROMVERSORUNG

Den Ofen an das Stromnetz anschließen, den Einschalter antippen und auf „I“ stellen (fig. 2,1-A). Wenn der Anschluss korrekt ist, gibt der Ofen mehrere aussetzende Signaltöne ab und das Display wird eingeschaltet.

! Bei längerem Stillstand wird empfohlen, den Schalter an der Ofenrückseite auf OFF (0) zu stellen.

☞ Vergewissern Sie sich, dass Sie der Einschalter nicht berühren, wenn Sie den Ofen an das Stromnetz anschließen.

⚠ Die Funktionstüchtigkeit des Ofens hängt von einer korrekten Stromzufuhr ab. Im Fall eines Stromausfalls darf der Ofen nicht eingeschaltet werden!

2.3 ANFÄNGLICHE EINSTELLUNGEN

Vor dem Gebrauch des Ofens müssen die Sprache, das Datum und die aktuelle Uhrzeit eingestellt werden.

2.3.1 Uhrzeit und datum einstellen

Zur Änderung des Datums:

- Mit den Tasten ◀ ▶ das Menü Setup  aufrufen und die Taste ↵ drücken;
- Mit der Taste + das Passwort „7“ anwählen und mit der Taste ↵ bestätigen;
- Mit der Taste + scrollen, das Untermenü [3] anwählen und mit der Taste ↵ bestätigen;
- Die Stunden blinken; den Wert mit den Tasten + - ändern und die Taste ▶ antippen;
- Die Minuten blinken; den Wert mit den Tasten + - ändern und die Taste ▶ antippen;
- Der Tag blinkt; den Wert mit den Tasten + - ändern und die Taste ▶ antippen;
- Der Monat blinkt; den Wert mit den Tasten + - ändern und die Taste ▶ antippen;
- Das Jahr blinkt; den Wert mit den Tasten + - ändern und die Taste ▶ antippen;
- Der aktuelle Wochentag blinkt (Montag = 1 ... Sonntag = 7); den Wert mit den Tasten + - ändern;
- Die eingegebenen Daten mit der Taste ↵ bestätigen.

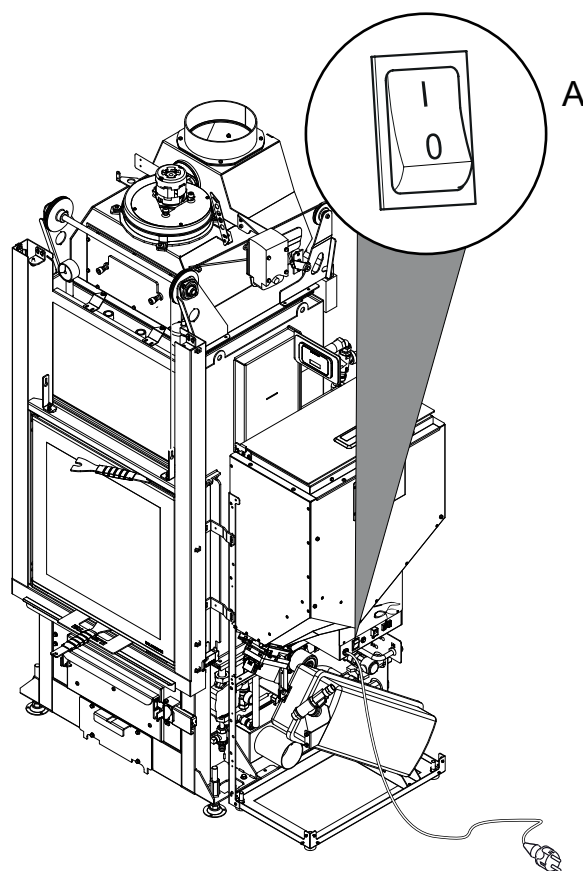













Fig. 2.1













2.3.2 Display-helligkeit einstellen

Der Benutzer kann einstellen, wie stark die Display-Helligkeit im Standby-Modus gedämpft wird.

- Mit den Tasten   das Menü Setup  aufrufen und die Taste  drücken;
- Mit der Taste  das Passwort "7" anwählen und mit der Taste  bestätigen;
- Mit der Taste  scrollen, das Untermenü [1 1] anwählen und mit der Taste  bestätigen;
- Mit den Tasten  und  den gewünschten Helligkeitswert einstellen (OFF, 1 ... 5) und mit der Taste  bestätigen;











2.3.3 Displaymodus einstellen

Der Benutzer kann einstellen, was auf dem Display angezeigt werden soll, wenn dieses auf Standby ist.

- Mit den Tasten   das Menü Setup  aufrufen und die Taste  drücken;
- Mit der Taste  das Passwort "7" anwählen und mit der Taste  bestätigen;
- Mit der Taste  scrollen, das Untermenü [1 2] anwählen und mit der Taste  bestätigen;
- Mit den Tasten  und  einen der folgenden Werte eingeben:
 - "OFF" • Das Display wird die letzte vom Benutzer betätigte Visualisierungsart zeigen;
 - "1" • Alle Funktionsparameter werden zyklisch gezeigt;
 - "2" • Die Temperatur wird gezeigt Raum (von der Raum-Sonde abgelesen);
 - "3" • Die aktuelle Zeit wird gezeigt;
 - "4" • Die Betriebsautonomie wird gezeigt, welche auf die fehlenden Stunden vor der Wiederfüllung vom Pelletsbehälter hinweist, Ob die Funktion Nachfüllung eingestellt ist (Bei Holzbetrieb wird das Symbol  angezeigt)
- Die eingegebenen Daten mit der Taste  bestätigen.











2.3.4 Summerlautstärke einstellen

Die Lautstärke des Signaltons kann nach Bedarf eingestellt werden:

- Mit den Tasten   das Menü Setup  aufrufen und die Taste  drücken;
- Mit der Taste  das Passwort "7" anwählen und mit der Taste  bestätigen;
- Mit der Taste  scrollen, das Untermenü [1 3] anwählen und mit der Taste  bestätigen;
- Mit den Tasten  und  die gewünschte Lautstärke einstellen (OFF, 1 ... 5) und mit der Taste  bestätigen;

2.3.5 Pelletart einstellen

Die Art der verwendeten Pellets kann wie folgt eingestellt werden:

- Mit den Tasten   das Menü Setup  aufrufen und die Taste  drücken;
- Mit der Taste  das Passwort "7" anwählen und mit der Taste  bestätigen;
- Mit der Taste  scrollen, das Untermenü [1 4] anwählen und mit der Taste  bestätigen;
- Mit den Tasten  und  einen der folgenden Werte eingeben:
 - "1" • Standardpellets (En Plus)
 - "2" • Längliche Pellets
 - "3" • Kleine Pellets
- Die eingegebenen Daten mit der Taste  bestätigen.

3 GEBRAUCH DES OFENS

3.1 VORWORT

Der Ofen bietet die Möglichkeit, die Verbrennung automatisch (nur bei Pelletbetrieb) oder manuell zu starten (nur bei Holzbetrieb).

Der automatische Start kann bei Pelletbetrieb auch programmiert werden.

In ausgeschaltetem Zustand ist der Ofen auf Holzbetrieb voreingestellt, was durch das Symbol  angezeigt wird (fig. 3.1).

Während der ersten Einschaltungen dürfen die lackierten Teile nicht berührt werden, um eine Beschädigung der Lackierung zu vermeiden.

! Während der ersten Einschaltung des Ofens können unter Umständen unangenehme Gerüche oder Rauch auftreten, die durch das Verdunsten oder Trocknen einiger verwendeter Materialien verursacht werden. Dieses Phänomen verschwindet mit der Zeit.

! Während der ersten Einschaltungen sollten die Räume gut gelüftet werden.

! Die Tür des Feuerraums darf immer nur kurzzeitig geöffnet werden, um zu vermeiden, dass der Türsensor über einen akustischen Alarm meldet, dass die Tür offen steht.

! Die Funktionstüchtigkeit des Ofens hängt von einer korrekten Stromzufuhr ab. Im Fall eines Stromausfalls darf der Ofen nicht eingeschaltet werden!

3.2 EINSCHALTUNG

3.2.1 Manuelle Einschaltung bei Holzbetrieb

Durchzuführende Vorgänge:

1. die Veranlagung zu gebrauchen (benutzen), fassen an und aufwärts zu pressen (fig. 3.2);
2. kleine Holzscheite auf den Boden des Feuerraums legen und vor allem darauf achten, dass der Beschickungskanal der Pellets nicht verstopft wird;
3. einen natürlichen Feueranzünder auf den Stapel positionieren, kreuzweise Stöcke aus feinem Holz darüber legen und den Feueranzünder von oben anzünden;
4. die Türe schließen, indem man die Klappe nach unten drückt, bis sie vollständig geschlossen ist.

Der Ofen regelt den Verbrennungsluftbedarf automatisch.

! **GEFAHR**

Zum Anzünden des Feuers nie Alkohol, Benzin, Kerosin oder sonstige flüssige Brennstoffe verwenden. Diese sind vom Feuer fern zu halten. Keine Feueranzünder verwenden, die aus Petroleum oder chemisch hergestellt sind. Ausschließlich umweltfreundliche Feueranzünder verwenden.

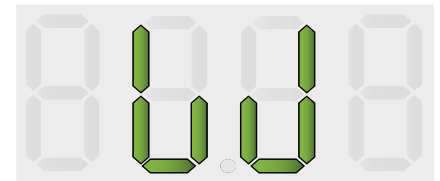

Fig. 3.1

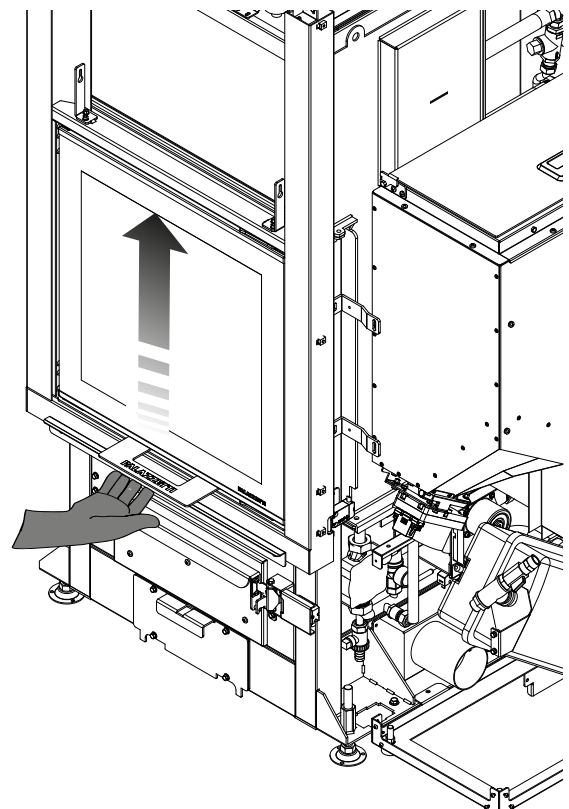



Fig. 3.2

Es wird empfohlen Holz nach zu laden erst wenn im Feuer Raum Glut besteht.

Halten Sie sich an der in den technischen Eigenschaften maximale empfohlene Holz menge um den Ofen nicht zu überlasten.

Wenn während des Holzbetriebs (Status ) ein Programm zur Einschaltung des Pelletbetriebs aufgerufen wurde, wechselt der Ofen nicht automatisch zum Pelletbetrieb, solange das Holz im Feuerraum noch brennt. Nach der Verbrennung des Holzes wird der Brenntopf automatisch gereinigt und, wenn sich das Programm noch innerhalb des aktiven Zeitintervalls befindet, schaltet sich der Ofen im Pelletbetrieb ein.

3.2.2 Automatische Einschaltung bei Pelletbetrieb

Sicherstellen, dass der Pelletbehälter eine ausreichende Menge Pellets enthält.

Zum Einschalten des Ofens die Taste  ein paar Sekunden lang gedrückt halten.

Während der Einschaltphase beginnt das Flammensymbol zu blinken und sobald der Ofen eingeschaltet ist, wechselt es auf Dauerlicht.

! Automatische Einschaltung: der Ofen verfügt über eine automatische Vorrichtung, mit der die Pellets ohne Zuhilfenahme anderer, herkömmlicher Anzündhilfen angezündet werden können.

3.3 ÄNDERUNG DER BETRIEBSPARAMETER

Die Betriebsparameter des Ofens können wie im Abschnitt 1.3 beschrieben geändert werden.





Die eingestellten Werte werden bis zur nächsten Änderung beibehalten, auch wenn der Ofen ausgeschaltet oder vom Stromnetz getrennt wird.

3.4 WECHSEL DES BRENNSTOFFS

Der Ofen bietet die Möglichkeit, die Brennstoffart zu wechseln (Holz/Pellets) während der Ofen in Betrieb ist.

3.4.1 Wechsel von Holz zu Pellets

Wenn während des Holzbetriebs zum automatischen Pelletbetrieb gewechselt werden soll, muss nur die Taste  für einige Augenblicke gedrückt werden:

1. die Betriebs-LED  beginnt zu blinken
2. nach der Verbrennung des Holzes führt der Ofen einen Reinigungsvorgang durch
3. nach der Reinigung schaltet der Ofen auf Pelletbetrieb und die Betriebs-LED  leuchtet dauerhaft.



Wenn die Umschaltung auf Pellets eingestellt ist, die Taste  einige Sekunden lang drücken und halten, um diese Funktion zu deaktivieren (die LED der Zündung  blinkt nicht mehr und es erscheint „OFF“).

3.4.2 Wechsel von Pellets zu Holz

Wenn während des Pelletbetriebs der Brennstoff gewechselt und auf Holzbetrieb geschaltet werden soll, einfach:

1. die Tür öffnen;
2. einige Holzscheite in den Brenntopf legen und besonders darauf achten, dass der Beschickungskanal der Pellets nicht verstopft wird
3. die Tür wieder schließen

Wenn genug Holz eingelegt wurde, schaltet der Ofen nach einigen Minuten automatisch auf Holzbetrieb, daher muss von Hand weiterer Brennstoff nachgelegt werden, wenn die Verbrennung aufrecht erhalten werden soll.

Die Symbole [PELL]= erscheinen auf dem Display des Brennstoffmenüs wenn sich der Ofen in Pelletposition befindet und [W]= wenn er sich in Holzposition befindet.

Auf dem Display erscheint im Menü des Brennstoffs .



Während des Beschickens mit Holz muss die Tür mindestens 3 Sekunden offen bleiben, um dem Ofen die Möglichkeit zu geben, den Vorgang zu bemerken.

3.5 AUSSCHALTUNG

3.5.1 Ausschaltung bei Holzbetrieb

Um den Ofen im Holzbetrieb auszuschalten, muss einfach kein Brennstoff mehr in den Feuerraum nachgelegt werden. Nach der Verbrennung des Holzes reinigt der Ofen den Brenntopf automatisch.

3.5.2 Ausschaltung bei Pelletbetrieb

Zum Ausschalten des Ofens im Pelletbetrieb die Taste  ein paar Sekunden lang gedrückt halten; das Flammensymbol erlischt.

Nach der Verbrennung reinigt der Ofen den Brenntopf automatisch.



Halten Sie sich beim Ausschalten des Ofens strikt an die obigen Anleitungen und schalten Sie ihn unter keinen Umständen durch Trennen der Spannungszufuhr aus.

3.6 BETRIEB MIT RAUMTHERMOSTAT (NUR BEI PELLETBETRIEB)

Wenn der Ofen von einem Raumthermostat (oder Uhrenthermostat) gesteuert wird, muss der Installationstechniker die Konfiguration 1 einstellen.

In dieser Konfiguration wird der Ofen ausgeschaltet, sobald die Wärmeanforderung des Raumthermostats erfüllt ist (Stromkreis offen), oder er moduliert seinen Betrieb bei Erreichen der eingestellten Wassertemperatur (das heißt, der Ofen versucht, die gewünschte Temperatur bei geringstmöglichem Verbrauch zu halten).

Der Ofen wird automatisch wieder eingeschaltet, wenn die Temperatur unter den am Raumthermostat eingestellten Wert abfällt (Stromkreis geschlossen).



Bei erstmaliger Einschaltung oder wenn die Ausschaltung direkt am Ofen (Taste ) erfolgt ist, muss der Ofen direkt vom Bedienpanel eingeschaltet werden.

Auch wenn trotz Modulation die Wassertemperatur weiterhin steigt, wird sich der Pelletofen ausschalten. In diesem Fall wird sich der Ofen nur dann wieder einschalten, wenn die Temperaturdifferenz zwischen Soll und Ist höher als 20°C ist.

Aus diesem Grund ist es ratsam, bei dieser Konfiguration die Soll-Wassertemperatur angemessen hoch einzustellen (z. B. 70°C).

3.7 BETRIEB MIT RAUMTEMPERATURFÜHLER AM OFEN

Der Ofen kann von Hand oder programmiert ein-/ausgeschaltet werden.

Bei dieser Konfigurationsart moduliert der Ofen die Leistung anhand der vom eingebauten Temperaturfühler gemessenen Raumtemperatur (das heißt, der Ofen versucht, die gewünschte Temperatur bei geringstmöglichem Verbrauch zu halten).

Falls der Benutzer im Untermenü [7] des Menü Setup , die Funktion „Eco-Mode“ aktiviert hat, moduliert der Ofen nicht, sondern schaltet bei Erreichen der Solltemperatur ab und erst dann wieder ein, wenn die Raumtemperatur unter den im Untermenü [8] des Menü Setup  angegebenen Differenzwert abfällt.

Die gewünschte Raumtemperatur kann im des Menüs Temperatur  eingestellt werden.

Über das **Untermenü [6] des Menü Setup ** kann die gewünschte Vorlauf-Wassertemperatur eingestellt werden (fragen Sie Ihren HLS-Installateur nach der optimalen Temperatur für Ihre Heizungsanlage).

3.8 BETRIEB IN KOMBINATION MIT EINEM SPEICHER

Für den Betrieb in Kombination mit einem Speicher muss der Installationstechniker abhängig davon, ob es sich um einen Speicher mit oder ohne interne Rohrwendel handelt, die Betriebskonfiguration 3 oder 4 einstellen.

Der Ofen wird anhand der vom Temperaturfühler im Speicher gemessenen Temperatur gesteuert.

Bei Erreichen der im Menü Temperatur  leingestellten Speicher-Temperatur wird der Ofen aus- und erst dann wieder eingeschaltet, wenn die Speicher-Temperatur unter den im Untermenü [8] des Menü Setup  angegebenen Differenzwert abfällt.

In dieser Konfiguration kann auch die Frostschutzfunktion eingestellt werden.

4 VERFÜGBARE FUNKTIONEN

4.1 TIMER

Mit dieser Funktion können die benutzerdefinierten Programme für das automatische Ein- und/oder Ausschalten des Ofens eingerichtet, aktiviert und den verschiedenen Wochentagen zugewiesen werden.

Es können bis zu sechs Programme eingerichtet werden.

Für jedes Programm kann eingestellt werden: Einschaltuhrzeit, Ausschaltuhrzeit und gewünschte Temperatur.

Jedem Wochentag können bis zu drei Programme zugewiesen werden.

Die Wochentage sind durch Zahlen gekennzeichnet: Montag = "d1", Dienstag = "d2";...; Sonntag = "d7".

4.1.1 Einstellung der programme

- Mit den Tasten das Menü Setup aufrufen und die Taste drücken;
- Mit der Taste das Passwort "7" anwählen und mit der Taste bestätigen;
- Das Untermenü wählen und mit der Taste bestätigen;
- Mit den Tasten durch die Programme P1...P6; blättern; mit der Taste das Programm auswählen, das bearbeitet werden soll;
- Die Stunden der Einschaltuhrzeit blinken; den Wert mit den Tasten ändern und die Taste antippen;
- Die Minuten blinken; den Wert mit den Tasten ändern und die Taste antippen;
- Die Stunden der Ausschaltuhrzeit blinken; den Wert mit den Tasten ändern und die Taste antippen;
- Die Minuten blinken; den Wert mit den Tasten ändern und die Taste antippen;
- Der Wert der gewünschten Temperatur blinkt; den Wert mit den Tasten und ändern;
- Die eingegebenen Daten mit der Taste bestätigen.

4.1.2 Zuordnen der programme an die tage

Mit dieser Funktion können einem bestimmten Tag bis zu drei verschiedene Programme zugewiesen werden.

- Mit den Tasten das Menü Setup aufrufen und die Taste drücken;
- Mit der Taste das Passwort "7" anwählen und mit der Taste bestätigen;
- Das Untermenü wählen und mit der Taste bestätigen.
- Mit den Tasten den Tag [d1]...[d7] wählen, dem die Programme zugewiesen werden sollen.
- Mit der Taste auswählen.
- Der Wert des ersten zuzuweisenden Programmes blinkt: P1...P6 oder "OFF", um es zu deaktivieren.
- Den Wert mit den Tasten ändern und die Taste antippen.
- Der Wert des zweiten zuzuweisenden Programmes blinkt: P1...P6 oder "OFF", um es zu deaktivieren.
- Den Wert mit den Tasten ändern und die Taste antippen.
- Der Wert des dritten zuzuweisenden Programmes blinkt: P1...P6 oder "OFF", um es zu deaktivieren.
- Den Wert mit den Tasten ändern und die Taste antippen, um die eingegebenen Daten zu bestätigen.

4.1.3 Timer aktivieren/deaktivieren

- Den Cursor mit den Pfeiltasten auf das Menü Timer setzen.
- Mit der Taste auswählen.
- Mit den Tasten blättern und wählen: "ON" zur Aktivierung des Timers oder "OFF" zur Deaktivierung.
- Die Taste drücken, um die Auswahl zu bestätigen.











Wenn der Timer aktiviert ist, erscheint das Symbol dauerhaft, um anzuzeigen, dass der Timer aktiv ist.

4.2 SPARFUNKTION “ECO MODE“(NUR BEI PELLETBETRIEB)

Bei Aktivierung dieser Funktion wird der Ofen bei Erreichen der gewünschten Raumtemperatur ausgeschaltet. Wenn diese Funktion nicht aktiviert ist, moduliert der Ofen seinen Betrieb, um die gewünschte Temperatur bei geringstmöglichem Verbrauch zu halten.

Die Funktion “Eco Mode” ist nur in Konfiguration 2 verfügbar.

Zur Aktivierung/Deaktivierung dieser Funkt:











- a) Mit den Tasten   das Menü Setup  aufrufen und die Taste  drücken;
- b) Mit der Taste  das Passwort “7” anwählen und mit der Taste  bestätigen;
- c) Das Untermenü [7] wählen und mit der Taste  bestätigen.
- d) Mit den Tasten   einen der folgenden Werte eingeben:
 - Eco → Die Funktion “Eco Mode” wird aktiviert;
 - Off → Die Funktion “Eco Mode” wird gesperrt.
- e) Die eingegebenen Daten mit der Taste  bestätigen.

4.3 FUNKTION EINSCHALTDIFFERENZ

Wiedereinschaltdifferenz: (Installationskonfigurationen 2, 3 und 4): Unterhalb der Ausschalttemperatur liegender Wert in Grad Celsius, bei dessen Überschreitung der Ofen automatisch wieder eingeschaltet wird. Wenn der Ofen zum Beispiel auf Ausschaltung bei 20°C eingestellt ist (Eco Mode aktiv) und eine „Einschaltdifferenz“ von 4°C eingegeben wird, schaltet sich der Ofen ein, sobald eine Temperatur von kleiner oder gleich 16°C gemessen wird.











Konfiguration 2:

Zur Änderung des Wertes der Einschaltdifferenz:

- a) Mit den Tasten   das Menü Setup  aufrufen und die Taste  drücken;
- b) Mit der Taste  das Passwort “7” anwählen und mit der Taste  bestätigen;
- c) Das Untermenü [8] anwählen und mit der Taste  bestätigen;
- d) Der Wert blinkt; den Wert mit den Tasten  und  ändern (0,5 ... 5,0°C);
- e) Die Taste  drücken, um den eingegebenen Wert zu bestätigen.

Konfiguration 3 und 4:

Zur Änderung des Wertes der Einschaltdifferenz:

- a) Mit den Tasten   das Menü Setup  aufrufen und die Taste  drücken;
- b) Mit der Taste  das Passwort “7” anwählen und mit der Taste  bestätigen;
- c) Das Untermenü [8] anwählen und mit der Taste  bestätigen;
- d) Der Wert blinkt; den Wert mit den Tasten  und  ändern (0 ... 40°C);
- e) Die Taste  drücken, um den eingegebenen Wert zu bestätigen.

4.4 FUNKTION BETRIEBSDAUER

Mit dieser Funktion kann angezeigt werden, wie viele Betriebsstunden noch verbleiben, bis Pellets nachgefüllt werden müssen. Wenn der Cursor mit den Pfeiltasten auf das Symbol  gesetzt wird, zeigt das Display die geschätzten Betriebsstunden bis zur nächsten Pelletsfüllung an. Die Betriebsdauer wird anhand der zu jenem Zeitpunkt am Ofen eingestellten Betriebsparameter berechnet.

Die Schätzwerte sind ausreichend zuverlässig, unter der Voraussetzung, dass bei jedem vollständigen Beschicken mit Pellets der Wert “FULL” angewählt und bestätigt wird. Der Wert “Lo” zeigt den Reservestatus an.

4.5 NACHFÜLLFUNKTION

Mit dieser Funktion kann dem Ofen gemeldet werden, dass gerade der Pelletbehälter gefüllt wird.

Auf diese Weise kann der Ofen anhand der Betriebsparameter ausrechnen, wie viele Betriebsstunden verbleiben, bevor der Pelletbehälter erneut gefüllt werden muss.

Nachdem der Behälter vollständig mit Pellets gefüllt wurde:

- a) Den Cursor mit den Pfeiltasten ◀ ▶ auf das Brennstoff-Symbol setzen  und die Eingabetaste ↵ antippen;
 - b) Mit den Tasten + - die Option „FULL“ wählen und die Eingabetaste ↵ antippen.
- Wenn diese Funktion deaktiviert werden soll, anstatt „FULL“ die Option „OFF“ wählen.



4.6 WIEDEREINSCHALTEN NACH STROMAUSFALL

Bei einem Stromausfall wird der Ofen bei Rückkehr der Stromversorgung nach Prüfung der erforderlichen Voraussetzungen automatisch wieder eingeschaltet.

4.7 FUNKTION „TASTATURSPERRE“

Mit dieser Funktion kann die Verwendung des Bedienpanels blockiert werden, um unbeabsichtigte Änderungen zu vermeiden.

Zur Aktivierung/Deaktivierung dieser Funktion:

- a) Mit den Tasten ◀ ▶ das Menü Setup  aufrufen und die Taste ↵ drücken;
- b) Mit der Taste + das Passwort „7“ anwählen und mit der Taste ↵ bestätigen;
- c) Das Untermenü [1 0] wählen und mit der Taste ↵.
- d) Mit den Tasten + - einen der folgenden Werte eingeben:
 - “Off” Tastatursperre deaktiviert
 - “Lo” Nur die Ein-/Ausschalttaste bleibt aktiviert 
 - “Hi” Tastatursperre aktiviert
- e) Die eingegebenen Daten mit der Taste ↵ bestätigen.

4.8 FROSTSCHUTZFUNKTION

In den Installationskonfigurationen 2, 3 und 4 kann eine Mindesttemperatur eingestellt werden, bei deren Unterschreitung der Ofen eingeschaltet wird (außerhalb der eingestellten Zeitintervalle).

Konfiguration 2:

Zur Änderung des Temperaturwerts „Frostschutz“:

- a) Mit den Tasten ◀ ▶ das Menü Setup  aufrufen und die Taste ↵ drücken;
- b) Mit der Taste + das Passwort „7“ anwählen und mit der Taste ↵ bestätigen;
- c) Das Untermenü [9] wählen und mit der Taste ↵ bestätigen;
- d) Der Wert blinkt; Wert mit den Tasten + - ändern (OFF; 3...20°C);
- e) Den eingegebenen Wert mit der Taste ↵ bestätigen.

Konfiguration 3 und 4:

Zur Änderung des Temperaturwerts „Frostschutz“:

- a) Mit den Tasten ◀ ▶ das Menü Setup  aufrufen und die Taste ↵ drücken;
- b) Mit der Taste + das Passwort „7“ anwählen und mit der Taste ↵ bestätigen;
- c) Das Untermenü [9] wählen und mit der Taste ↵ bestätigen;
- d) Der Wert blinkt; Wert mit den Tasten + - ändern (OFF; 3...50°C);
- e) Den eingegebenen Wert mit der Taste ↵ bestätigen.

Wenn unter Punkt d. der Wert „OFF“ eingegeben wird, wird diese Funktion deaktiviert.

4.9 MANUELLE AKTIVIERUNG DES PELLETNACHFÜLLSYSTEMS

Beim erstmaligen Einschalten oder wenn der Behälter vollständig leer ist, besteht die Möglichkeit, nach dem Befüllen des Behältnisses mit Pellets das Nachfüllsystem manuell zu aktivieren, sodass die Pellets korrekt in den Kreislauf gelangen:

- a) Rufen Sie über die Pfeiltasten ◀ ▶ das Einstellungsmenü  auf und drücken Sie die Taste ↵;
- b) Geben Sie mit der Taste + das Passwort „7“ ein und bestätigen Sie mit der Taste ↵;
- c) Wählen Sie das Untermenü [3 1] und bestätigen Sie mit der Taste ↵;
- d) Geben Sie das Passwort „54“ ein;
- e) Halten Sie die Taste ↵ gedrückt, um das manuelle Nachfüllsystem zu aktivieren.



Dieses Verfahren kann nur bei ausgeschaltetem und vollständig abgekühltem Ofen aktiviert werden.

4.10 MANUELLE AKTIVIERUNG DES MECHANISCHEN KOHLENBECKENREINIGUNGSSYSTEMS

Falls es erforderlich sein sollte, das mechanische Kohlenbeckenreinigungssystem manuell zu aktivieren, kann dies wie folgt durchgeführt werden:

- a) Rufen Sie über die Pfeiltasten ◀ ▶ das Einstellungsmenü ⚙ auf und drücken Sie die Taste ↵;
- b) Geben Sie mit der Taste + das Passwort "7" ein und bestätigen Sie mit der Taste ↵;
- c) Wählen Sie das Untermenü [32] und bestätigen Sie mit der Taste ↵;
- d) Geben Sie das Passwort "54" ein und bestätigen Sie mit der Taste ↵;
- e) Halten Sie die Taste ↵ gedrückt, um das manuelle Nachfüllsystem zu aktivieren.





Dieses Verfahren kann nur bei ausgeschaltetem und vollständig abgekühltem Ofen durchgeführt werden.

5 VERWALTUNG DER ALARMMELDUNGEN

5.1 BESCHREIBUNG DER MELDUNGEN

Bei Auftreten einer Betriebsstörung wird die folgende Prozedur aktiviert:

- 1) Akustischer Alarm (Piepton);
- 2) Eine der folgenden System-LEDs leuchtet auf:   .
- 3) Wenn die Störung einen Fehler betrifft, wird der Ofen ausgeschaltet (falls in pellet Betrieb).

Durch anhaltendes Drücken der Taste „Abbrechen“  wird der Fehlercode auf dem Display angezeigt:

FEHLERCODE MELDUNG	BESCHREIBUNG	MÖGLICHE URSACHEN	LED
E001	Bedienpanel defekt	Defekt des Bedienfelds	
E002	Kommunikationsfehler Fernbedienungssignal	Defekt des Bedienfelds	
E004	Kommunikationsfehler	Verbindungskabel zwischen Platine und Bedienpanel unterbrochen oder getrennt. Wenn dieser Fehler während des Konfigurationswechsels auftritt, kann er ignoriert werden.	
E101	Fehlgeschlagene Einschaltung Vorlaufwasser zu heiß	Keine Pellets vorhanden Pelletsqualität Einschaltssystem defekt Brenntopf verschmutzt Probleme der Heizungsanlage Probleme der Umwälzpumpe	
E104	Kohlenbeckenreinigungssystem blockiert	Ein Fremdkörper verhindert die Funktionstüchtigkeit des Reinigungssystems des Kohlenbeckens.	  
E105	Fehlbetrieb des Temperaturfühlers	Wassertemperaturfühler am Rücklauf defekt	
E106	Fehlbetrieb des Temperaturfühlers	Pufferfühler / Raum Temperatur Fühler defekt	
E107	Fehlfunktion Sonde im Brennraum	Sensor defekt	
E108	Thermischer Sicherheitsfehler	Probleme der Heizungsanlage Probleme der Umwälzpumpe Probleme durch Überhitzung des Pelletbehälters	
E109	Druck- oder Luftkontrollfehler	Rauchabzugssystem verschmutzt Dichtungen verschlissen Unzureichende Verbrennungsluft Probleme beim Kontrollsystem der Verbrennungsluft	
E110	Fehlbetrieb des Temperaturfühlers	Wassertemperaturfühler am Vorlauf defekt	
E111	Fehlbetrieb des Abgasfühlers	Abgastemperaturfühler defekt	
A002	Hinweis auf programmierte Wartung (Symbole blinken)	Der Ofen fordert regelmäßig die Durchführung der Wartung durch einen Fachtechniker an	  
A006	Hinweis auf offene Türen oder Fächer	Ofentür oder Aschefach offen	  
A007	Fehlbetrieb des Druckfühlers. (Symbole blinken)	Druckfühler oder Platine defekt.	
----	Ofenreinigung	Brennkammer, Brenntopf oder Rauchabzugssystem verschmutzt. Druckmessrohre getrennt oder verstopft. Verbrennungslufteintritt verstopft.	
----	Fehlgeschlagene Einschaltung	Pellets aufgebraucht; Zündwiderstand defekt; Dichtungen verschlissen; Ofentür offen.	

5.2 ZURÜCKSETZEN DER ALARME

Nach Überprüfung der Art der Meldung kann der Alarm zurückgesetzt werden, indem die Ein-/Ausschalttaste einige Sekunden lang gedrückt wird (⏻).

5.2.1 Sonderfälle (dem technischen Kundendienst vorbehalten):

Fehler "E 108"

Falls der Fehlercode "E 108" angezeigt wird, könnte eine erneute manuelle Aktivierung des Thermostats (Abb. 5.1) erforderlich sein. Schrauben Sie hierfür die Schutzkappe ab und drücken Sie die Nachfülltaste.

Setzen Sie den Alarm zurück, indem Sie ein paar Sekunden auf die Ein-/Aus-Taste drücken (⏻).

Nun kann das Gerät erneut eingeschaltet werden.

Fehler "E 104"

Falls die Fehlermeldung "E 104" angezeigt wird, gehen Sie wie folgt vor:

- Versuchen Sie, etwaige Fremdkörper aus dem Kohlenkasten zu entfernen.
- Wenn diese nicht zu entfernen sind, fahren Sie mit der manuellen Aktivierung des mechanischen Kohlenbeckenreinigungssystems fort:

- Rufen Sie über die Pfeiltasten (◀ ▶) das Einstellungs Menü (⚙️) auf und drücken Sie die Taste (↔);
- Geben Sie mit der Taste (+) das Passwort "7" ein und bestätigen Sie mit der Taste (↔);
- Wählen Sie das Untermenü [32] und bestätigen Sie mit der Taste (↔);
- Geben Sie das Passwort "54" ein und bestätigen Sie mit der Taste (↔);
- Die Taste (↔) einige Sekunden lang gedrückt halten, um einen Reinigungszyklus der Brennschale zu aktivieren.

- Drücken Sie während der Reinigung fünf Sekunden lang den Mikroschalter (Abb. 5.2) und achten Sie darauf, dass die Ofentür geschlossen bleibt.
- Öffnen Sie die Ofentür wieder und vergewissern Sie sich, dass das Kohlenbecken frei von Fremdkörpern ist.
- Setzen Sie den Alarm zurück, indem Sie ein paar Sekunden auf die Ein-/Aus-Taste drücken (⏻).
- Warten Sie einige Minuten und schalten Sie das Gerät erneut ein.



Dieses Verfahren kann nur bei ausgeschaltetem und vollständig abgekühltem Ofen durchgeführt werden.

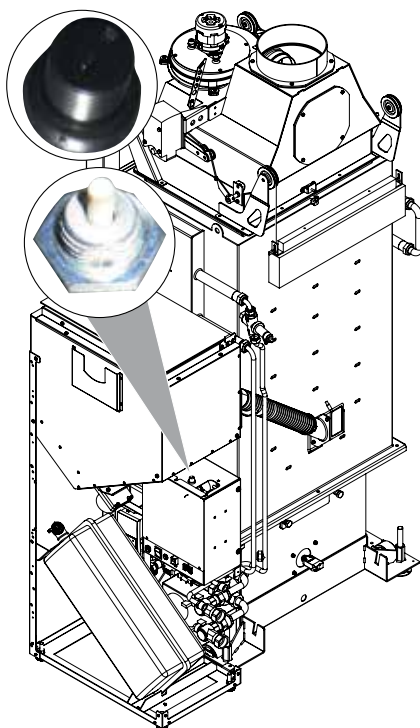

Fig. 5.1

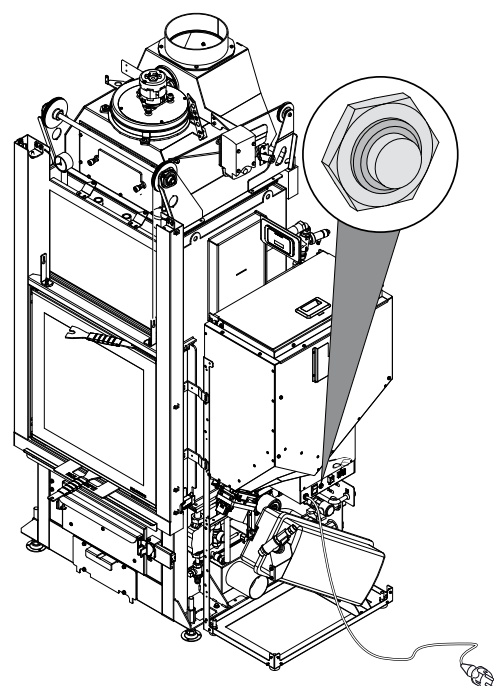

Fig. 5.2

INDEX

1 PANNEAU DE COMMANDE

- 1.1 DESCRIPTION
- 1.2 UTILISATION DU CLAVIER DE COMMANDE
- 1.3 PARAMÈTRES DE FONCTIONNEMENT

2 OPERATIONS PRELIMINAIRES

- 2.1 REMPLISSAGE DES PELLETS
- 2.2 ALIMENTATION ELECTRIQUE
- 2.3 PARAMÉTRAGES PRÉLIMINAIRES

3 UTILISATION DU POËLE

- 3.1 PRÉAMBULE
- 3.2 ALLUMAGE
- 3.3 MODIFICATION DES PARAMÈTRES
- 3.4 CHANGEMENT TYPE DE COMBUSTIBLE
- 3.5 ARRÊT
- 3.6 FONCTIONNEMENT AVEC UN THERMOSTAT AMBIANT (UNIQUEMENT À GRANULÉS)
- 3.7 FONCTIONNEMENT AVEC UNE SONDE AMBIANTE INSTALLÉE SUR LE POËLE
- 3.8 FONCTIONNEMENT ASSOCIÉ À UN BALLON D'EAU CHAUDE

4 FONCTIONS DISPONIBLES

- 4.1 FONCTION TIMER
- 4.2 FONCTION ÉCONOMIE "ECO MODE" (UNIQUEMENT EN MODE PELLETS)
- 4.3 FONCTION DELTA DE RALLUMAGE
- 4.4 FONCTION AUTONOMIE
- 4.5 FONCTION RAVITAILLEMENT
- 4.6 RALLUMAGE APRÈS UNE COUPURE DE COURANT
- 4.7 FONCTION "BLOCAGE CLAVIER"
- 4.8 FONCTION ANTIGEL
- 4.9 ACTIVATION MANUELLE DU SYSTEME DE CHARGEMENT DE PELLETS
- 4.10 ACTIVATION MANUELLE DU SYSTEME MECANIQUE DE NETTOYAGE DES CENDRES

5 GESTION DES ALARMES

- 5.1 DESCRIPTION DES MESSAGES
- 5.2 REINITIALISATION DES ALERTES

1 PANNEAU DE COMMANDE

Avant de procéder à la lecture de cette notice veuillez consulter de la description du poêle contenue dans la "notice technique" jointe.

1.1 DESCRIPTION

Composition du clavier de commande:







- A) la partie haute avec les LEDS d'état et les icônes rétro éclairées identifiant chaque fonction,
- B) écran à LEDS,
- C) touche d'allumage (⏻),
- D) touche "Annuler" et affichage "Alarme" (⏮),
- E) deux touches flèche pour se déplacer dans les différents menus (⏪ ⏩);
- F) deux touches (+) et (-) pour accéder aux sous-menus et modifier les paramètres de fonctionnement;
- G) touche envoi (⏭) pour confirmer le paramètre ou la sélection.









Fig. 1.1

 S'agissant d'un clavier capacitif tactile, il suffit juste d'appuyer les touches pour les activer.

1.1.1 Leds d'état

ICONE	MESSAGE	DESCRIPTION
	Pellets en cours d'épuisement.	Elle signale qu'il faut remplir la trémie de pellets
	Entretien	Elle signale qu'il faut effectuer une opération d'entretien (peut s'afficher également en cas de pression répétée de la touche ON)
	Assistance	Elle signale le déclenchement d'une alarme
	Récepteur de la télécommande	Il reçoit les commandes par la télécommande (optionnel)
	Timer activé	Elle signale l'activation de la fonction timer
	Led signalant l'état (près de la touche ⏻)	Led allumée: signale que le poêle est en marche Led clignotante: signale que le poêle est en cours d'allumage ou en veille Led éteint: signale que le poêle est éteint

1.1.2 Description des menus

ICON	FUNCTION	DESCRIPTION	VALEURS
	Puissance	Mise au point de la puissance de fonctionnement	1..5
	Ventilation	Sur les modèles à eau, ce paramètre n'est pas prévu	
	Temperature	Affiche la température lue par la sonde* et permet de programmer la température voulue. *config.1: sonde de l'eau chaude; config.2: sonde ambiante; config. 3-4: sonde externe/ballon d'eau chaude.	config.1: 65..80 °C config.2: 10.. 48 °C config.3-4: 45..75 °C
	Fuel	[PELL] = Pellets [W] = Bois	
	Timer	Active ou désactive la minuterie. Quand la minuterie est activée l'icône  est affichée fixe.	ON - OFF

ICON	FUNCTION	SUBMENU	DESCRIPTION	VALEURS
	Mise au point	[1] Minuterie hebdomadaire	Affectation des programmes (max 3) aux différents jours de la semaine	[d1] ... [d7]
		[2] Programmes	Configuration des programmes	[P1] ... [P6]
		[3] Horloge / date	Réglage de l'horloge et de la date	
		[4] Heures résiduelles	Affiche le nombre d'heures restantes jusqu'au prochain entretien préconisé. La valeur "Hi" indique un nombre supérieur à 999 heures.	
		[5] Informations de système	Affiche la version du logiciel en cours	
		[6] Température de l'eau	Permet de régler la température désirée pour l'eau (uniquement en configuration 2).	60 ... 80°C
		[7] Fonction Eco	Active ou désactive le mode Eco qui permet l'arrêt et le rallumage automatique en fonction de la température ambiante (uniquement en configuration 2).	OFF; Eco
		[8] Delta de rallumage	ce sont les degrés centigrades sous la température d'extinction au-delà duquel le poêle se rallume automatiquement (Sauf dans les configuration 1).	0,5 ... 5,0°C 0 ... 40°C
		[9] Température hors-gel	Température minimum en dessous de laquelle le poêle s'allume (Sauf dans les configuration 1).	OFF; 3 ... 20 °C OFF; 3 ... 50 °C
		[10] Verrouillage clavier	Configuration verrouillage des touches	OFF; Lo; Hi
		[11] Luminosité écran	Règle le degré de luminosité de l'écran	OFF; 1 ... 5
		[12] Mode affichage	Configuration de l'affichage des données	OFF; 1 ... 4
		[13] Volume avertisseur sonore	Configuration du volume de l'avertisseur sonore	OFF; 1 ... 5
		[14] Type de pellets	Il est possible de programmer 3 types de pellets différents	1 ... 3
		[30] Menu installateur	Modifie/affiche la configuration du poêle	PWD: "54"
		[31] Chargement pellets	Activation manuelle du système de chargement de pellets	
[32] Attiseur	Activation manuelle du système mécanique de nettoyage des cendres			
[33] Alimentation de la pompe	Menu destiné au SAV.			
[40] Menu de service	Menu destiné au SAV.			

Les sous-menus [30] et [40] du menu Configuration sont protégés par un mot de passe et sont à l'usage exclusif du service d'assistance technique.

1.2 UTILISATION DU CLAVIER DE COMMANDE

- L'effleurement des touches flèche ◀ ▶ fait défiler les différents menus qui s'illuminent au fur et à mesure.
- Pour modifier les réglages d'une fonction donnée il suffit d'appuyer sur la touche ← quand elle s'affiche et d'en modifier les valeurs avec les touches + -.
- Appuyer de nouveau sur la touche ← pour confirmer la modification.
- En général tous les paramètres qui clignotent peuvent être modifiés à l'aide des touches + -.
- La touche "Annuler" ⇐ permet d'annuler la modification; Un effleurement prolongé permet d'afficher le code de l'alarme qui s'est éventuellement déclenchée.

1.3 PARAMÈTRES DE FONCTIONNEMENT

Le fonctionnement du poêle est lié au paramétrage de la puissance et de la température.

1.3.1 Modification de la puissance

La puissance correspond à la quantité de chaleur produite par le poêle, et influe donc directement sur la consommation.

Pour modifier la puissance, sélectionner le menu puissance 🔥 avec les touches ◀ ▶.

- Faire défiler le sous-menu avec les touches + -.
- Sélectionner le sous-menu "1" et confirmer avec la touche ←.
- Le paramètre de la puissance se met à clignoter; le modifier avec les touches + - (1 minimum, ..., 5 maximum).
- Effleurer la touche ← pour confirmer la mise au point.

1.3.2 Modification de la température

En fonction de la configuration d'installation du poêle, il est possible de mettre au point différents paramètres de température:

- A l'aide des touches ◀ ▶ sélectionner le menu température 🌡 et appuyer sur ←;
- Le paramètre en cours se met à clignoter, le modifier avec les touches + -;
- Appuyer la touche ← pour confirmer la mise au point.

Température eau (uniquement dans les configurations d'installation 1): la modification de ce paramètre modifie la température souhaitée de refoulement de l'eau chaude par le poêle.

Température ambiante (uniquement dans la configuration d'installation 2): la modification de ce paramètre définit la température ambiante que l'on souhaite atteindre et qui sera directement lue par la sonde installée sur le poêle.

Température ballon d'eau chaude (uniquement dans les configurations d'installation 3 et 4): c'est la température minimum que l'on souhaite maintenir dans le ballon d'eau chaude.

2 OPERATIONS PRELIMINAIRES

2.1 REMPLISSAGE DES PELLETS



La première opération à effectuer avant d'allumer le poêle est celle de remplir la trémie de pellets.

Les pellets doivent être versés dans la trémie avec une petite pelle.

Ne pas vider directement le sac dans la trémie pour ne pas y jeter de la sciure ou des corps étrangers qui pourraient nuire au bon fonctionnement du poêle, et ne pas verser de pellets en dehors de la trémie.

 Veiller à bien refermer le couvercle de la trémie après avoir chargé les pellets.

 Si on veut utiliser la fonction «autonomie» il faut, à l'aide des touches flèches  , se positionner sur l'icône combustible  et appuyer sur entrée .

Sélectionner «FULL» à l'aide des touches   et appuyer sur entrée .

Si on veut désactiver cette fonction sélectionner «STOP» au lieu de «FULL».

2.2 ALIMENTATION ELECTRIQUE

Brancher le poêle au secteur en plaçant l'interrupteur d'allumage (Fig. 2.1- A) sur "I". La mise sous tension est signalée par une série de bips par intermittence et par l'allumage de l'écran.

 En prévision d'une longue période d'inactivité, il est conseillé de placer l'interrupteur sur OFF (0).

 En branchant le poêle à une prise de courant, s'assurer de ne pas toucher le panneau de commande.



























 Le fonctionnement du poêle nécessite une alimentation électrique correcte. En l'absence de courant, ne pas allumer le poêle !

2.3 PARAMÉTRAGES PRÉLIMINAIRES

Avant d'utiliser le poêle, il faut programmer la langue, la date et l'heure en cours.

2.3.1 Paramétrage de l'heure et de la date

Pour modifier la date:

- A l'aide des touches  , sélectionner le menu Configuration  et appuyer sur .
- Sélectionner le mot de passe "7" avec la touche  et confirmer avec la touche .
- À l'aide de la touche , sélectionner le sous-menu [3] et confirmer avec la touche .
- Le paramètre de l'heure se met à clignoter, le modifier avec les touches   puis appuyer la touche .
- Le paramètre des minutes se met à clignoter, le modifier avec les touches   puis appuyer la touche .
- Le paramètre du jour se met à clignoter, le modifier avec les touches   puis appuyer la touche .
- Le paramètre du mois se met à clignoter, le modifier avec les touches   puis appuyer la touche .
- Le paramètre de l'année se met à clignoter, le modifier avec les touches   puis appuyer la touche .
- Le paramètre du jour de la semaine en cours (lundi = 1... dimanche = 7) se met à clignoter, le modifier avec les touches  .
- Appuyer la touche  pour confirmer la mise au point.

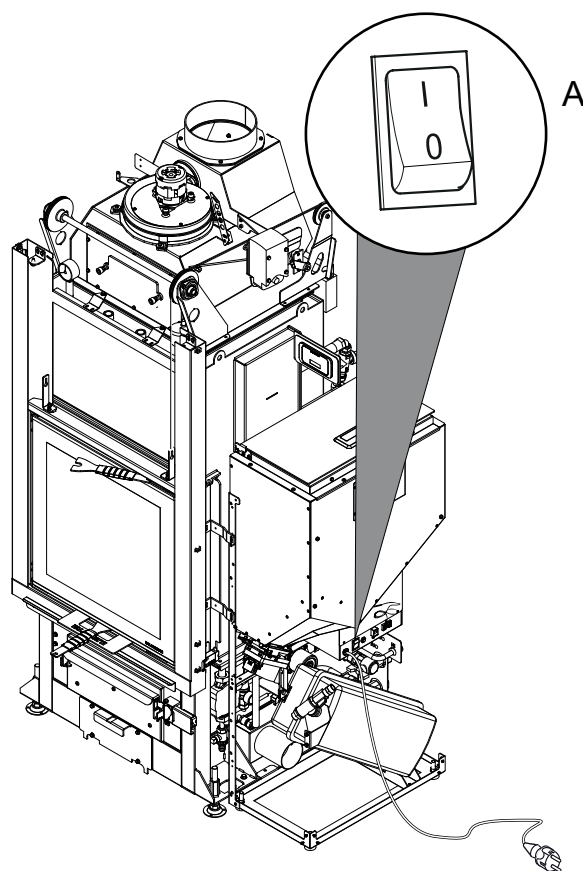

Fig. 2.1

2.3.2 Mise au point de la luminosité de l'écran

Il est possible de mettre au point la luminosité de l'écran lorsqu'il est en mode veille.

- A l'aide des touches ◀ ▶, sélectionner le menu Configuration ⚙ et appuyer sur ⏪;
- Sélectionner le mot de passe "7" avec la touche + et confirmer avec la touche ⏪;
- À l'aide de la touche +, sélectionner le sous-menu [1 1] et confirmer avec la touche ⏪;
- Régler la luminosité souhaitée (OFF, 1 ... 5) à l'aide des touches + et -, puis confirmer avec la touche ⏪.

2.3.3 Mise au point de l'affichage

Il est possible de mettre au point les objets que l'on souhaite afficher lorsque l'écran est en veille.

A l'aide des touches flèche ◀ ▶ sélectionner le menu de mise au point ⚙;

- A l'aide des touches ◀ ▶, sélectionner le menu Configuration ⚙ et appuyer sur ⏪;
- Sélectionner le mot de passe "7" avec la touche + et confirmer avec la touche ⏪;
- À l'aide de la touche +, sélectionner le sous-menu [1 2] et confirmer avec la touche ⏪;
- Mettre au point avec les touches + et - l'un des paramètres suivants:
 - "OFF" • L'afficheur va vous montrer la dernière visualisation réalisée par le client;
 - "1" • Vous allez visualiser cycliquement tous les paramètres;
 - "2" • Vous allez visualiser la température (lue par la sonde ambiante).
 - "3" • Vous allez visualiser l'heure actuelle
 - "4" • Vous allez visualiser les heures d'autonomie avant de recharger le réservoir d'alimentation, si la fonction "ravitaillement" a été validé (le symbole 🔋 s'affiche pendant le fonctionnement à bois).
- Appuyer la touche ⏪ pour confirmer la mise au point.

2.3.4 Mise au point du volume de l'avertisseur sonore

Il est possible de mettre au point le volume de l'avertisseur sonore en fonction de ses exigences.

- A l'aide des touches ◀ ▶, sélectionner le menu Configuration ⚙ et appuyer sur ⏪;
- Sélectionner le mot de passe "7" avec la touche + et confirmer avec la touche ⏪;
- À l'aide de la touche +, sélectionner le sous-menu [1 3] et confirmer avec la touche ⏪;
- Régler le volume souhaité (OFF, 1 ... 5) à l'aide des touches + et -, puis confirmer avec la touche ⏪.

2.3.5 Mise au point du type de pellet

Il est possible de mettre au point le type de pellet employé.

- A l'aide des touches ◀ ▶, sélectionner le menu Configuration ⚙ et appuyer sur ⏪;
- Sélectionner le mot de passe "7" avec la touche + et confirmer avec la touche ⏪;
- À l'aide de la touche +, sélectionner le sous-menu [1 4] et confirmer avec la touche ⏪;
- Mettre au point avec les touches + et - l'un des paramètres suivants:
 - "1" • Pellets standard (En Plus)
 - "2" • Pellets longs
 - "3" • Pellets courts
- Appuyer la touche ⏪ pour confirmer la mise au point.

3 UTILISATION DU POÊLE

3.1 PRÉAMBULE

L'allumage du poêle peut être automatique (uniquement pour les granulés) ou manuel (uniquement pour le bois).

Il est possible également de programmer l'allumage automatique en mode granulés.

Lorsque le poêle est éteint il est prêt pour le mode bois indiqué par le symbole  (fig.3.1).

Ne pas toucher les parties peintes lors des premiers allumages pour éviter d'endommager la peinture.

! Lors du premier allumage du poêle il peut se dégager des odeurs désagréables ou des fumées causées par l'évaporation ou le séchage de certains matériaux utilisés. Ce phénomène disparaîtra petit à petit.

! Il est conseillé, lors des premiers allumages, d'aérer la pièce.

! Ne pas laisser la porte du foyer ouverte pour éviter que le capteur de fermeture ne détecte l'état de porte ouverte et ne déclenche une alarme sonore.

! Le fonctionnement du poêle nécessite une alimentation électrique correcte. En l'absence de courant, ne pas allumer le poêle !

3.2 ALLUMAGE

3.2.1 Allumage manuel pour le bois

Opérations à effectuer:

1. utiliser la poignée à disposition et pousser vers le haut (fig. 3.2);
2. mettre du petit bois sur la sole foyère en faisant attention à ne pas boucher la goulotte d'acheminement des granulés;
3. placez un allume-feu naturel sur le tas, ajoutez dessus des brindilles de bois entrelacées et allumez l'allume-feu par le haut ;
4. refermez la porte en la poussant vers le bas jusqu'à sa fermeture complète.

Le poêle règle automatiquement les besoins en air comburant.

! DANGER

Pour allumer le feu ne jamais utiliser d'alcool, d'essence, de kérosène, ou autres combustibles liquides.

Stocker ceux-ci loin du poêle.

Ne pas utiliser d'allume-feux à base de produits pétroliers ou d'origine chimique.

Utiliser exclusivement des allume-feux d'origine naturelle.

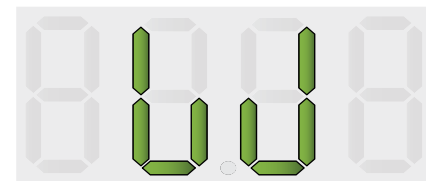

Fig. 3.1

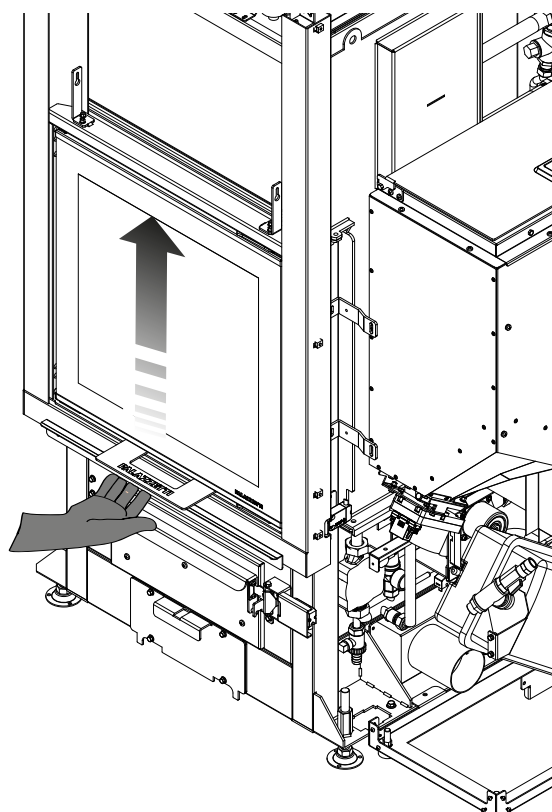



Fig. 3.2

Il faut effectuer l'opération de chargement du bois lorsque que la charge précédente se soit réduite en braises.

Il est interdit de surcharger la chambre de combustion, il faut toujours suivre les limites de consommation horaire du combustible indiqué dans les caractéristiques techniques.

Si lors du fonctionnement à bûches (état ) un programme d'allumage pour granulés a été activé, le poêle ne bascule pas automatiquement en mode granulés tant qu'il reste du bois à brûler dans le foyer. À la fin de la combustion des bûches un cycle automatique de nettoyage du brasier est effectué et si le programme est encore dans la plage horaire active le poêle s'allumera en mode granulés.

3.2.2 Allumage automatique à granulés

S'assurer que la trémie à granulés contient une quantité suffisante de granulés.

Pour allumer le poêle appuyer sur la touche  pendant quelques secondes.

L'icône en forme de flamme clignote pendant la phase d'allumage, et reste fixe quand le poêle est allumé.

! Allumage automatique: le poêle est muni d'un dispositif automatique qui permet l'allumage sans l'utilisation d'autres allumeurs traditionnels.

3.3 MODIFICATION DES PARAMÈTRES DE FONCTIONNEMENT

Il est possible de modifier les paramètres de fonctionnement du poêle comme indiqué au paragraphe 1.3.





Les valeurs programmées seront maintenues jusqu'à la prochaine modification, même si le poêle est éteint ou débranché de l'alimentation électrique.

3.4 CHANGEMENT TYPE DE COMBUSTIBLE



Il est possible de changer de type de combustible (bois/granulés) pendant le fonctionnement du poêle.

3.4.1 Passer du bois aux granulés

Si pendant le fonctionnement à bois on veut passer au fonctionnement automatique à granulés il suffit d'appuyer sur la touche  pendant quelques secondes:

1. La led d'allumage  commence à clignoter
2. à la fin de la combustion du bois le poêle effectuera une opération de nettoyage
3. après le nettoyage le poêle passera en fonctionnement granulés et la led d'allumage  restera fixe.



Si le passage à granulés a été configuré, maintenez quelques instants la touche  enfoncée pour désactiver cette fonction (le voyant d'allumage  ne clignotera plus, et le message "OFF" apparaîtra).

3.4.2 Passer des granulés aux bûches de bois

Si pendant le fonctionnement granulés on veut changer de combustible et passer aux bûches de bois il suffit de:

1. ouvrir la porte
2. charger quelques bûches de bois dans le foyer en faisant attention à ne pas boucher la goulotte d'acheminement des granulés
3. refermer la porte

Si la charge de bois est suffisante le poêle se met automatiquement en fonctionnement bûches au bout de quelques minutes, il sera donc nécessaire de recharger manuellement le poêle pour prolonger la combustion.

Les symboles [PELL]= apparaissent sur l'affichage du menu carburant lorsque le poêle est en position pellet et [W]= lorsqu'il est en position bois.

Le symbole  s'affiche sur le menu du combustible.



Lors du chargement des bûches il est nécessaire que la porte reste ouverte pendant plus de 3 secondes pour que le poêle détecte l'opération.

3.5 ARRÊT

3.5.1 Arrêt lors du fonctionnement à bûches

Pour éteindre le poêle lors du fonctionnement à bûches il suffit de ne pas recharger le foyer en bois.

À la fin de la combustion du bois le poêle effectuera une opération de nettoyage du brasier.

3.5.2 Arrêt lors du fonctionnement à granulés

Pour éteindre le poêle quand il est en fonctionnement à granulés, appuyer sur la touche  pendant quelques secondes; l'icône en forme de flamme s'éteint.

À la fin de la combustion, le poêle effectuera un cycle automatique de nettoyage du brasier.



Il est recommandé d'éteindre le poêle en suivant scrupuleusement ce qui vient d'être dit et d'éviter absolument de l'éteindre en débranchant l'alimentation électrique.

3.6 FONCTIONNEMENT AVEC UN THERMOSTAT AMBIANT (UNIQUEMENT À GRANULÉS)

En cas de contrôle du poêle avec un thermostat (ou chrono-thermostat) extérieur, l'installateur doit programmer la configuration 1.

Dans cette configuration, le poêle s'éteint lorsque le thermostat extérieur se déclenche (circuit ouvert) ou module son fonctionnement (le poêle maintient la température mise au point en consommant le moins possible) lorsque la température programmée de l'eau est atteinte.

Le poêle se rallume automatiquement lorsque la température descend sous la valeur mise au point sur le thermostat extérieur (circuit fermé).



Au premier allumage ou si le poêle a été éteint depuis le clavier de commande (touch ) , le rallumage doit s'effectuer depuis le clavier de commande.



Le poêle s'arrêtera aussi si la température continue à augmenter malgré la modulation. Dans ce cas le poêle va se mettre en marche seulement si la différence entre la valeur de la température choisie et la température real est supérieur à 20°C.

Nous vous conseillons donc, dans ce type de configuration, de régler la température de l'eau sur une valeur haute (ex. 70°C).

3.7 FONCTIONNEMENT AVEC UNE SONDE AMBIANTE INSTALLÉE SUR LE POÊLE

Le poêle peut être allumé/éteint manuellement ou de façon programmée.

Dans ce type de configuration, le poêle module sa puissance en fonction de la température ambiante lue par la sonde à bord (le poêle maintient la température mise au point en consommant le moins possible).

Si la fonction "Eco-mode" a été activée dans le sous-menu [7] du menu Configuration  , au lieu de moduler sa puissance, le poêle s'éteint lorsque la température programmée a été atteinte, et se rallume lorsque la température ambiante descend sous le delta défini dans le sous-menu [8] du menu Configuration .



Il est possible de mettre au point la température ambiante souhaitée dans le menu température .

Le sous-menu [6] du menu Configuration  permet de programmer la température de l'eau de refoulement (se renseigner auprès de son installateur pour connaître la température la mieux adaptée à son installation de chauffage).

3.8 FONCTIONNEMENT ASSOCIÉ À UN BALLON D'EAU CHAUDE

Pour un fonctionnement associé à un ballon d'eau chaude, l'installateur programmera la configuration 3 ou 4 selon qu'il s'agisse d'un ballon d'eau chaude avec ou sans serpentin interne.

Le poêle est contrôlé par la température lue par la sonde dans le ballon d'eau chaude..

Lorsque l'eau dans le ballon atteint la température programmée dans le menu température  le poêle s'éteint et se rallume si la température descend sous le delta défini dans le sous-menu [8] du menu Configuration .

Dans cette configuration, il est aussi possible de mettre au point la fonction antigel.

4 FONCTIONS DISPONIBLES

4.1 FONCTION TIMER

Cette fonction permet de programmer et d'assigner aux différents jours de la semaine des programmes personnalisés permettant d'allumer et/ou d'éteindre automatiquement le poêle.



























Il est possible de mettre au point jusqu'à six programmes personnalisés.

Dans chaque programme on peut mettre au point l'heure d'allumage et d'extinction ainsi que la température souhaitée.

Il est possible d'assigner jusqu'à 3 programmes pour chaque jour de la semaine.



















Les jours de la semaine sont identifiés par un chiffre allant de 1 à 7 : lundi = "d1", mardi = "d2" ;... ; dimanche = "d7".

4.1.1 Mise au point des programmes







- A l'aide des touches  , sélectionner le menu Configuration  et appuyer sur ;
- Sélectionner le mot de passe "7" avec la touche  et confirmer avec la touche ;
- Sélectionner le sous-menu [2] et confirmer avec la touche ;
- A l'aide des touches   faire défiler les programmes P1...P6 ; à l'aide de la touche  sélectionner celui que l'on souhaite modifier.
- Le paramètre de l'heure d'allumage se met à clignoter; modifier le paramètre avec les touches   puis appuyer la touche ;
- Le paramètre des minutes se met à clignoter; modifier le paramètre avec les touches   puis appuyer la touche ;
- Le paramètre de l'heure d'extinction se met à clignoter; modifier le paramètre avec les touches   puis appuyer la touche ;
- Le paramètre des minutes se met à clignoter; modifier le paramètre avec les touches   puis appuyer la touche ;
- Le paramètre de la température souhaitée se met à clignoter; modifier le paramètre avec les touches   puis appuyer la touche ;
- Appuyer la touche  pour confirmer la mise au point.

4.1.2 Assignation des programmes aux jours de la semaine

Cette fonction permet d'assigner jusqu'à 3 programmes différents à un jour déterminé.

- A l'aide des touches  , sélectionner le menu Configuration  et appuyer sur ;
- Sélectionner le mot de passe "7" avec la touche  et confirmer avec la touche ;
- Sélectionner le sous-menu [1] et confirmer avec la touche ;
- Sélectionner avec les touches   le jour [d1]...[d7] auquel on souhaite associer les programmes;
- Le sélectionner avec la touche ;
- Le paramètre du premier programme à assigner se met à clignoter: P1...P6 ou "OFF" pour le désactiver;
- Modifier le paramètre avec les touches   puis appuyer la touche ;
- Le paramètre du deuxième programme à assigner se met à clignoter: P1...P6 ou "OFF" pour le désactiver;
- Modifier le paramètre avec les touches   puis appuyer la touche ;
- Le paramètre du troisième programme à assigner se met à clignoter: P1...P6 ou "OFF" pour le désactiver;
- Modifier le paramètre avec les touches   puis appuyer la touche  pour confirmer la mise au point.

4.1.3 Activation / désactivation du timer











- A l'aide des touches flèche   sélectionner le menu Timer .
- Confirmer avec la touche ;
- A l'aide des touches   faire défiler et sélectionner: "ON" pour activer le timer ou "OFF" pour le désactiver.
- Appuyer la touche  pour confirmer la sélection.

Quand la minuterie est activée l'icône fixe  s'affiche .

4.2 FONCTION ÉCONOMIE “ECO MODE” (UNIQUEMENT EN MODE PELLETS)

Cette fonction éteint le poêle lorsque la température ambiante programmée est atteinte. Si cette fonction n'est pas activée, le poêle module son fonctionnement pour maintenir la température programmée en consommant le moins possible. La fonction “Eco Mode” n'est disponible que dans la configuration 2.

Pour activer/désactiver cette fonction:











- A l'aide des touches  , sélectionner le menu Configuration  et appuyer sur .
- Sélectionner le mot de passe “7” avec la touche  et confirmer avec la touche .
- Sélectionner le sous-menu [7] et confirmer avec la touche .
- Mettre au point avec les touches   l'un des paramètres suivants:
Eco → Validation de la fonction “Eco Mode”
Off → Désactivation de la fonction “Eco Mode”
- Appuyer la touche  pour confirmer la mise au point.

4.3 FONCTION DELTA DE RALLUMAGE

Delta de rallumage: (dans les configurations d'installation 2, 3 et 4): ce sont les degrés centigrades sous la température d'extinction au-delà duquel le poêle se rallume automatiquement. Par exemple, si le poêle est programmé pour s'éteindre à 20°C (Eco Mode activé) et le “Delta de rallumage” a été défini à 4°C, le poêle se rallumera lorsqu'il aura relevé une température inférieure ou égale à 16°C.











Configuration 2:

Pour modifier la valeur du delta de rallumage:

- A l'aide des touches  , sélectionner le menu Configuration  et appuyer sur .
- Sélectionner le mot de passe “7” avec la touche  et confirmer avec la touche .
- Sélectionner le sous-menu [8] et confirmer avec la touche .
- Le paramètre se met à clignoter, le modifier avec les touches  et  (0,5 ... 5,0°C);
- Appuyer sur la touche  pour confirmer.

Configuration 3 e 4:

Pour modifier la valeur du delta de rallumage:

- A l'aide des touches  , sélectionner le menu Configuration  et appuyer sur .
- Sélectionner le mot de passe “7” avec la touche  et confirmer avec la touche .
- Sélectionner le sous-menu [8] et confirmer avec la touche .
- Le paramètre se met à clignoter, le modifier avec les touches  et  (0 ... 40°C);
- Appuyer sur la touche  pour confirmer.

4.4 FONCTION AUTONOMIE

Cette fonction permet d'afficher les heures d'autonomie restantes avant de devoir faire le ravitaillement en pellets. A l'aide des touches flèche, sélectionner l'icône  l'écran affichera les heures d'autonomie estimées avant de devoir faire le ravitaillement en pellets. L'autonomie est calculée sur la base des paramètres définis à ce moment- là sur le poêle.







Les valeurs estimées sont suffisamment fiables à condition que la valeur «FULL» soit sélectionnée et confirmée à chaque remplissage complet de pellets. La valeur «Lo» indique l'état de réserve.

4.5 FONCTION RAVITAILLEMENT

Cette fonction permet d'enregistrer le remplissage de pellets dans la trémie.

Ainsi et, sur la base des paramètres de fonctionnement, le poêle est en mesure de calculer les heures d'autonomie avant de devoir remplir à nouveau la trémie.

Après avoir rempli complètement la trémie de pellets:

- A l'aide des touches flèche   sélectionner l'icône du combustible  puis appuyer la touche envoi .
 - A l'aide des touches   sélectionner l'indication “FULL” puis appuyer la touche envoi .
- Pour désactiver cette fonction, sélectionner “OFF” au lieu de “FULL”.

4.6 RALLUMAGE APRÈS UNE COUPURE DE COURANT

Après une interruption de courant, le poêle se rallume automatiquement et effectue un autodiagnostic au retour de l'alimentation.

4.7 FONCTION "BLOCAGE CLAVIER"

Cette fonction permet de bloquer le clavier de commande afin de prévenir toute modification intempestive.

Pour activer/désactiver cette fonction:

- A l'aide des touches ◀ ▶, sélectionner le menu Configuration ⚙ et appuyer sur ⏪;
- Sélectionner le mot de passe "7" avec la touche + et confirmer avec la touche ⏪;
- Sélectionner le sous-menu [1 0] et confirmer avec la touche ⏪;
- à l'aide des touches + - mettre au point l'un des paramètres suivants:
 - "Off" Verrouillage clavier désactivé
 - "Lo" seule la touche allumage/extinction ⏻ est activée
 - "Hi" Verrouillage clavier activé
- Appuyer la touche ⏪ pour confirmer la mise au point.

4.8 FONCTION ANTIGEL

Les configurations d'installation 2, 3 et 4 permettent de mettre au point une température minimum en dessous de laquelle le poêle s'allume (en-dehors des tranches horaires programmées).

Configuration 2:

Pour modifier le paramètre de la température "antigel":

- A l'aide des touches ◀ ▶, sélectionner le menu Configuration ⚙ et appuyer sur ⏪;
- Sélectionner le mot de passe "7" avec la touche + et confirmer avec la touche ⏪;
- Sélectionner le sous-menu [9] et confirmer avec la touche ⏪;
- Le paramètre se met à clignoter, le modifier avec les touches + - (OFF; 3...20°C);
- Appuyer la touche ⏪ pour confirmer la mise au point.

Configuration 3 e 4:

Pour modifier le paramètre de la température "antigel":

- A l'aide des touches ◀ ▶, sélectionner le menu Configuration ⚙ et appuyer sur ⏪;
- Sélectionner le mot de passe "7" avec la touche + et confirmer avec la touche ⏪;
- Sélectionner le sous-menu [9] et confirmer avec la touche ⏪;
- Le paramètre se met à clignoter, le modifier avec les touches + - (OFF; 3...50°C);
- Appuyer la touche ⏪ pour confirmer la mise au point.

En entrant "OFF" à l'étape d, cette fonction sera désactivée.

4.9 ACTIVATION MANUELLE DU SYSTEME DE CHARGEMENT DE PELLETS

Au premier allumage, ou si le réservoir est totalement vide, il est possible, après avoir chargé les pellets dans le réservoir d'activer manuellement le système de charge de sorte que les pellets remplissent correctement le circuit :

- Utiliser les flèches ◀ ▶ pour atteindre le menu de configuration ⚙ et appuyer sur la touche ⏪;
- Sélectionner l'option 7 avec la touche + et valider avec la touche ⏪;
- Sélectionner le sous-menu [3 1] et confirmer avec la touche ⏪;
- Sélectionner l'option "54"
- Maintenir la touche enfoncée ⏪ pour activer le système de chargement manuel.



Ce mode ne peut être activé que lorsque le poêle est éteint et totalement froid.

4.10 ACTIVATION MANUELLE DU SYSTEME MECANIQUE DE NETTOYAGE DES CENDRES

Si le système mécanique de nettoyage des cendres doit être activé, suivre la procédure suivante :

- a) Utiliser les flèches ◀ ▶ pour atteindre le menu de configuration ⚙ et appuyer sur la touche ⏎;
- b) Sélectionner l'option 7 avec la touche + et valider avec la touche ⏎;
- c) Sélectionner le sous-menu [32] et confirmer avec la touche ⏎ ;
- d) Sélectionner l'option "54" et confirmer avec la touche ⏎ ;
- e) Maintenir la touche enfoncée ⏎ pour activer le système de chargement manuel.







Cette fonction ne peut être activée que lorsque le poêle est éteint et totalement froid.

5 GESTION DES ALARMES

5.1 DESCRIPTION DES MESSAGES

Un dysfonctionnement est signalé par la procédure suivante:

- 1) avertissement sonore (bip);
- 2) allumage de l'une des icônes suivantes:   ;
- 3) s'il s'agit d'une alarme, le poêle s'éteint (si en fonctionnement à granulés);

L'effleurement prolongé de la touche "annuler"  affiche le code de l'alarme:

CODE ALARME / MESSAGE	DESCRIPTION	CAUSES PROBABLES	LED
E001	Clavier de commande défectueux	Défaut du clavier de commande	
E002	Non réception du signal de la télécommande	Défaut du clavier de commande	
E004	Coupure de liaison	Coupure ou débranchement du câble reliant la carte au clavier de commande. Ignorer cette alarme, si elle s'affiche pendant le changement de configuration.	
E101	Allumage raté. Eau de refoulement trop chaude.	Absence de pellets Qualité du pellet Défaut du système d'allumage Brasero sale Problèmes sur l'installation de chauffage Problèmes sur le circulateur	
E104	Système de nettoyage des cendres bloqué	Un corps étranger empêche le fonctionnement correct du système de nettoyage de la base du collecteur de cendres.	  
E105	Dysfonctionnement sonde de température	Sonde eau de retour défectueuse	
E106	Dysfonctionnement sonde de température	Dysfonctionnement de la sonde (puffer / ambient)	
E107	Dysfonctionnement de la sonde dans la chambre de combustion	Sonde dans la chambre de combustion défectueuse	
E108	Déclenchement du disjoncteur	Problèmes sur l'installation de chauffage Problèmes sur le circulateur Surchauffe de la trémie de pellets	
E109	Erreur de pression ou de contrôle de l'air	Système d'évacuation des fumées sales Joints d'étanchéité endommagés Air comburant insuffisant Problèmes au niveau du système de contrôle de l'air comburant	
E110	Dysfonctionnement sonde de température	Sonde eau de refoulement défectueuse	
E111	Dysfonctionnement sonde fumée	Sonde température fumée défectueuse	
A002	Avertissement entretien programmé (icônes clignotantes)	Le poêle requiert un entretien régulier à effectuer par un personnel spécialisé.	 
A006	Avis porte ou tiroir ouverts	Porte du foyer ou tiroir du collecteur de cendres ouverts	  
A007	Dysfonctionnement capteur de pression (icône clignotante)	Défaut du capteur de pression ou de la carte	
----	Nettoyage du poêle	Chambre de combustion, braséro ou système d'évacuation de la fumée sales. Encrassement ou décrochement des tuyaux de relevé de la pression. Encrassement de l'arrivée de l'air comburant.	
----	Allumage raté	Absence de pellets; Défaut de la résistance d'allumage; Joints usés; Porte du foyer ouvert.	

5.2 REINITIALISATION DES ALERTES

Après avoir vérifié le message, l'alarme peut être effacée en appuyant pendant quelques secondes la touche d'allumage/extinction (⏻).

5.2.1 Cas particuliers (pris en charge par le Centre d'assistance technique) :

Erreur "E 108"

En présence du code d'erreur "E 108", il peut être nécessaire de réactiver les thermostats manuellement (Fig. 5.1). Dévisser les bouchons de protection et appuyer sur les boutons d'activation.

Réinitialiser l'alerte en appuyant pendant quelques instants sur la touche d'allumage/extinction (⏻).

A ce stade, une nouvelle mise sous tension est possible.

Erreur "E 104"

En présence du code d'erreur "E 104" procéder comme suit :

- Essayer de retirer les corps étrangers éventuels du collecteur de cendres.
- En cas de blocage, procéder à l'activation manuelle du système mécanique de nettoyage du collecteur de cendres:

- a) Utiliser les flèches (◀) (▶) pour atteindre le menu de configuration (⚙️) et appuyer sur la touche (↔);
- b) Sélectionner l'option 7 avec la touche (+) et valider avec la touche (↔);
- c) Sélectionner le sous-menu [32] et confirmer avec la touche (↔);
- d) Sélectionner l'option "54" et confirmer avec la touche (↔);
- e) Maintenez la touche (↔) enfoncée quelques secondes pour activer un cycle de nettoyage du foyer.

- Lancer le nettoyage et appuyer pendant cinq secondes sur le micro-interrupteur (Fig. 5.2) en laissant la porte du poêle.
- Rouvrir la porte et vérifier si le corps étranger a bien été éliminé.
- Réinitialiser l'alerte en appuyant pendant quelques instants sur la touche d'allumage/extinction.
- Attendre quelques instants avant de procéder à une nouvelle mise sous tension.



Cette fonction ne peut être activée que lorsque le poêle est éteint et totalement froid.

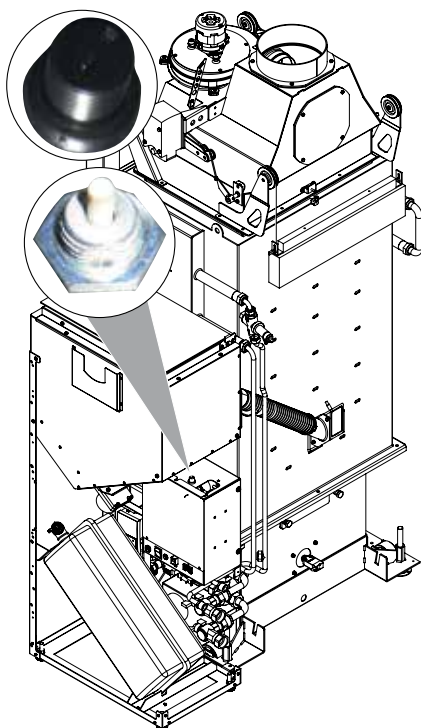

Fig. 5.1

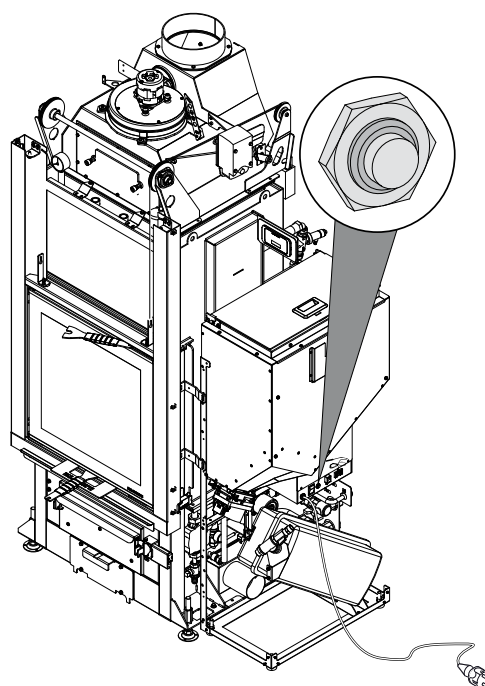

Fig. 5.2

ÍNDICE

1 PANEL DE MANDOS

- 1.1 DESCRIPCIÓN
- 1.2 USO DEL PANEL DE MANDO
- 1.3 PARÁMETROS DE FUNCIONAMIENTO

2 OPERACIONES PRELIMINARES

- 2.1 CARGA DE LOS PELLETS
- 2.2 ALIMENTACIÓN ELÉCTRICA
- 2.3 PROGRAMACIONES INICIALES

3 USO DE LA ESTUFA

- 3.1 PREMISA
- 3.2 ENCENDIDO
- 3.3 MODIFICACIÓN DE LOS PARÁMETROS
- 3.4 CAMBIO DE COMBUSTIBLE
- 3.5 APAGADO
- 3.6 FUNCIONAMIENTO CON TERMOSTATO AMBIENTE (SÓLO CON PELLETS)
- 3.7 FUNCIONAMIENTO CON Sonda AMBIENTE A BORDO CALDERA
- 3.8 FUNCIONAMIENTO EN COMBINACIÓN CON UN DEPÓSITO

4 FUNCIONES DISPONIBLES

- 4.1 FUNCIÓN TEMPORIZADOR
- 4.2 FUNCIÓN AHORRO "ECO MODE"(SÓLO EN MODO PELLET)
- 4.3 FUNCIÓN DELTA DE REENCENDIDO
- 4.4 FUNCIÓN AUTONOMÍA
- 4.5 FUNCIÓN RECARGA
- 4.6 REENCENDIDO DESPUÉS DEL BLACK-OUT
- 4.7 FUNCIÓN "BLOQUEO BOTONERA"
- 4.8 FUNCIÓN ANTICONGELACIÓN
- 4.9 ACTIVACIÓN MANUAL DEL SISTEMA DE CARGA DE PELLET
- 4.10 ACTIVACIÓN MANUAL DEL SISTEMA MECÁNICO DE LIMPIEZA DEL BRASERO

5 GESTIÓN DE LAS ALARMAS

- 5.1 DESCRIPCIÓN DE LOS MENSAJES
- 5.2 RESET DE LAS ALARMAS

1 PANEL DE MANDOS

Antes de leer el manual, consultar la descripción de la estufa en el apartado “Manual del Producto”.

1.1 DESCRIPCIÓN

El panel de mando se compone de:















- A) una parte superior con los led de estado y los iconos con iluminación posterior que identifican cada función;
- B) visor de led;
- C) botón de encendido ;
- D) botón “Anular” y visualización “error” ;
- E) dos botones flecha para desplazarse por las diferentes funciones  ;
- F) Dos botones  y  para modificar los parámetros de funcionamiento y entrar a los submenús;
- G) un tasto de envío  para confirmar el parámetro o su selección.









Fig. 1.1

 *Todos los botones son de tipo capacitivo por lo tanto no necesitan ser presionados para su activación, es suficiente tocar la superficie.*

1.1.1 Led de estado

ICONO	AVISO	DESCRIPCIÓN
	Pellet acabándose	Indica que es necesario recargar el depósito de pellet.
	Mantenimiento	Indica que es necesario realizar un mantenimiento (también puede aparecer cuando se presiona de modo repetido el botón ON)
	Asistencia	Indica la presencia de error.
	Receptor del mando a distancia	Recibe los comandos del control remoto (opcional).
	Temporizador activo	Indica si está activa la función temporizador
	Led de señalización estado (cerca del botón )	Led siempre encendido: estufa encendida y en funcionamiento Led intermitente: Estufa en fase de encendido o en stand-by Led apagado: Estufa apagada

1.1.2 Descripción de los menús

ICONO	FUNCIÓN	DESCRIPCIÓN	VALORES
	Potencia	Programación de la potencia de funcionamiento	1..5
	Ventilación	En los modelos de agua este parámetro no es activado	
	Temperature	Muestra la temperatura leída por la sonda* y permite programar la temperatura deseada. *config.1: sonda agua caliente; config.2: sonda ambiente; config. 3-4: sonda externa/depósito.	config.1: 65..80 °C config.2: 10.. 48 °C config.3-4: 45..75 °C
	Combustible	[PELL] = Pellets [W] = Madera	
	Timer	Habilita o deshabilita el Temporizador. Cuando está habilitado muestra el icono fijo 	ON - OFF

ICONO	FUNCIÓN	SUBMENU	DESCRIPCIÓN	VALORES
	Setup	[1] Temporizador semanal	Asignación de los programas (máx. 3) a los diferentes días de la semana	[d1] ... [d7]
		[2] Programas	Menú de configuración de los programas	[P1] ... [P6]
		[3] Reloj /fecha	Programación reloj y fecha	
		[4] Horas Restantes	Visualiza las horas faltantes aconsejadas para el mantenimiento. Con el valor "Hi" se indica un número de horas superior a 999.	
		[5] Informaciones del sistema	Visualiza la versión software actual	
		[6] Temperatura agua	Permite ajustar la temperatura deseada para el agua (sólo en la configuración 2).	60 ... 80°C
		[7] Función Eco	Habilita o no el Modo Eco que implica el apagado y reencendido automático en función de la temperatura ambiente (sólo en la configuración 2).	OFF; Eco
		[8] Delta de reencendido	Es el número de grados centígrados por debajo de la temperatura de apagado superado el cual la estufa se reenciende automáticamente (excepto en la configuración 1).	0,5 ... 5,0°C 0 ... 40°C
		[9] Temperatura anticongelación	Temperatura mínima por debajo de la cual la estufa se enciende (excepto en la configuración 1).	OFF; 3 ... 20°C OFF; 3 ... 50°C
		[10] Bloqueo botonera	Programa el modo de bloqueo de los datos	OFF; Lo; Hi
		[11] Luminosidad del visor	Programa el grado de luminosidad del visor	OFF; 1 ... 5
		[12] Modo visor	Programa el modo de visualización de los datos	OFF; 1 ... 4
		[13] Volumen timbre eléctrico	Programa el volumen del aviso acústico	OFF; 1 ... 5
		[14] Tipo de pellet	Se pueden programar 3 tipos diferentes de pellets	1 ... 3
		[30] Menú instalador	Modifica/visualiza la configuración de la estufa	PWD: "54"
		[31] Carga de pellet	Activación manual del sistema de carga de pellet	
[32] Limpieza del brasero	Activación manual del sistema mecánico de limpieza del brasero			
[33] Alimentación bomba	Menú de competencia del centro de asistencia			
[40] Menú de servicio	Menú de competencia del centro de asistencia			

Los submenús [30] y [40] del menú Setup están protegidos con una contraseña y son de uso exclusivo del centro de asistencia técnico.

1.2 USO DEL PANEL DE MANDO

- Usando las flechas ◀ ▶ se desliza entre los diferentes menús que se iluminan cada vez.
- Deteniéndose en una función determinada basta usar el botón ↵ y modificar sus valores con los botones + -.
- Otra presión del botón ↵ confirma la modificación.
- En general todos los valores que parpadean en ese momento se pueden modificar con los botones + -.
- El botón “anular” ⏏ permite anular la modificación; su presión prolongada permite la visualización en el visor de un posible código de alarma o de error.

1.3 PARÁMETROS DE FUNCIONAMIENTO

El funcionamiento de la estufa depende de los parámetros de Potencia y Temperatura programados por el usuario.

1.3.1 MODIFICACIÓN DE LA POTENCIA

La potencia define la cantidad de calor producida por la estufa y por lo tanto incide directamente también en los consumos.

Para modificar la potencia ir con los botones ◀ ▶ al menú potencia 🔥

- a) Pasar con los botones + - el submenú.
- b) Seleccionar el submenú “1” y confirmar con el botón ↵.
- c) Parpadeará el valor de potencia, modificar el valor con los botones + - (1 mínimo,...,5 máximo).
- d) Presionar el botón ↵ para confirmar los datos programados.

1.3.2 Modificación de la temperatura

En función de la configuración instalada en la caldera es posible cambiar los diferentes valores de temperatura:

- a) Usando los botones ◀ ▶ ir al menú temperatura 🌡 y pulsar el botón ↵ ;
- b) Parpadeará el valor actual, modificarlo con los botones + - ;
- c) Presionar el botón ↵ para confirmar el dato programado.

Temperatura agua (sólo en las configuraciones de instalación 1): cambiando este valor se cambia la temperatura deseada de entrada del agua caliente por parte de la caldera.

Temperatura ambiente (sólo en la configuración de instalación 2): modificando dicho valor se define la temperatura que se desea alcanzar en el ambiente, leída directamente por una sonda situada en la caldera.

Temperatura depósito (sólo en las configuraciones de instalación 3 y 4): identifica la temperatura mínima que se desea mantener dentro del depósito.

2 OPERACIONES PRELIMINARES

2.1 CARGA DE LOS PELLETS

La primera operación a realizar antes de encender el producto es llenar el depósito de combustible (pellet).

No cargar directamente de la bolsa para evitar de descargar aserrín u otros elementos extraños que pueden afectar el buen funcionamiento de la estufa y para evitar que se esparzan pellets fuera del depósito.

☞ Asegurarse que se ha cerrado bien la tapa del depósito después que se realiza la operación de carga de pellets.

☞ Si se desea aprovechar la función "autonomía" a partir de aquí, ir con los botones flecha ◀ ▶ al icono combustible 🔥 y presionar enviar ↵. Seleccionar con los botones + - la sigla "FULL" y presionar enviar ↵.

Si se desea deshabilitar dicha función, en lugar de "FULL" seleccionar "OFF".

2.2 ALIMENTACIÓN ELÉCTRICA

Conectar la estufa a la red eléctrica, usar el interruptor de encendido (Fig. 2.1-A) posicionándolo en "I". Si la conexión es correcta, la estufa emitirá una serie de señales acústicas intermitentes, y se enciende el visor.

! Para períodos prolongados de desuso, se aconseja posicionar el interruptor en la posición OFF (0).

☞ Asegurarse de no tocar el panel de mando cuando se conecta la estufa a la red eléctrica.

⚠ El funcionamiento de la estufa está supeditado a una alimentación eléctrica correcta. En caso de falta de energía eléctrica, no encender la estufa!

2.3 PROGRAMACIONES INICIALES

Antes de utilizar la estufa es necesario programar el idioma, la fecha y la hora corriente.

2.3.1 Programación horario

Para modificar la fecha:

- Usando los botones ◀ ▶ ir al menú setup ⚙ y pulsar el botón ↵;
- Seleccionar la contraseña "7" con el botón + y confirmar con el botón ↵;
- Pasar con el botón +, seleccionar el submenú [3] y confirmar con el botón ↵;
- Parpadeará el valor de la hora, modificar el valor con los botones + - y presionar el botón ▶;
- Parpadeará el valor de los minutos, modificar el valor con los botones + - y presionar el botón ▶;
- Parpadeará el valor del día, modificar el valor con los botones + - y presionar el botón ▶;
- Parpadeará el valor del mes, modificar el valor con los botones + - y presionar el botón ▶;
- Parpadeará el valor del año, modificar el valor con los botones + - y presionar el botón ▶;
- Parpadeará el valor del día corriente de la semana (Lunes = 1... Domingo = 7) modificar el valor con los botones + -;
- Presionar el botón ↵ para confirmar los datos programados.

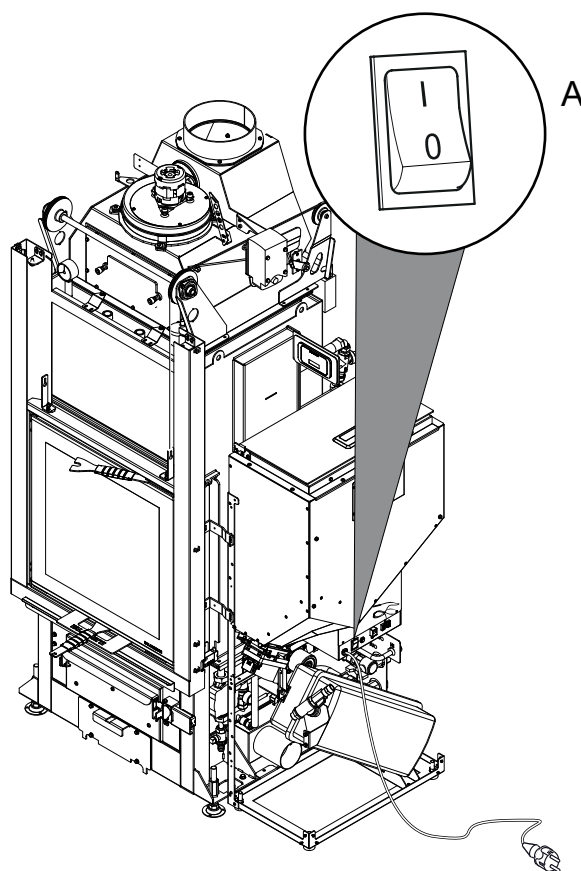



Fig. 2.1



2.3.2 Programación luminosidad visor

Se puede programar el grado de atenuación de la luminosidad del visor cuando está en el modo standby.

- Usando los botones ◀ ▶ ir al menú setup  y pulsar el botón ⏪;
- Seleccionar la contraseña "7" con el botón + y confirmar con el botón ⏪;
- Pasar con el botón +, seleccionar el submenú [1 1] y confirmar con el botón ⏪;
- Programar con los botones + y - el valor de luminosidad deseado (OFF, 1 ... 5) y confirmar con el botón ⏪.

2.3.3 Programaciones modo visor

Es posible programar lo que se querrá visualizar en el visor cuando éste esté en el modo standby.

- Usando los botones ◀ ▶ ir al menú setup  y pulsar el botón ⏪;
- Seleccionar la contraseña "7" con el botón + y confirmar con el botón ⏪;
- Pasar con el botón +, seleccionar el submenú [1 2] y confirmar con el botón ⏪;
- Programar con los botones + y - uno de los siguientes valores:
 - "OFF"** • El panel muestra la última visualización efectuada por el usuario;
 - "1"** • Se visualizan de manera cíclica todos los parametros de funcionamiento;
 - "2"** • Se visualiza la temperatura (leída por la sonda ambiente).
 - "3"** • Se visualiza la hora actual.
 - "4"** • Se visualizan las horas de autonomía que faltan antes de recargar el depósito de alimentación, Si la función "abastecimiento" a sido activada o el símbolo  aparece si se está en modo leña
- Presionar el botón ⏪ para confirmar los datos programados.

2.3.4 Programación del volumen

Es posible programar el nivel de volumen del timbre eléctrico en función de las propias necesidades:

- Usando los botones ◀ ▶ ir al menú setup  y pulsar el botón ⏪;
- Seleccionar la contraseña "7" con el botón + y confirmar con el botón ⏪;
- Pasar con el botón +, seleccionar el submenú [1 3] y confirmar con el botón ⏪;
- Programar con los botones + y - el nivel de volumen deseado (OFF, 1 ... 5) y confirmar con el botón ⏪.

2.3.5 Programación tipo de pellet

Es posible programar el tipo de pellet que se va a utilizar:

- Usando los botones ◀ ▶ ir al menú setup  y pulsar el botón ⏪;
- Seleccionar la contraseña "7" con el botón + y confirmar con el botón ⏪;
- Pasar con el botón +, seleccionar el submenú [4] y confirmar con el botón ⏪;
- Seleccionar el submenú "2" y confirmar con el botón + y - uno de los siguientes valores:
 - "1"** • Pellet estándar (En Plus)
 - "2"** • Pellet largo
 - "3"** • Pellet pequeño
- Presionar el botón ⏪ para confirmar los datos programados.

3 USO DE LA ESTUFA

3.1 PREMISA

La estufa ofrece la posibilidad de realizar la puesta en marcha de la combustión de modo automático (sólo con pellets) o manual (sólo con leña).

La puesta en marcha automática con pellets también puede producirse de modo programado.

En el estado apagado, la estufa está preparada en el modo leña indicado por el símbolo  (fig.3.1).

Durante los primeros encendidos, no tocar las partes pintadas para evitar daños en la pintura.

! En el primer encendido de la estufa, se pueden generar desagradables olores o humos debidos a la evaporación o el secado de algunos materiales utilizados.

! Este fenómeno desaparecerá gradualmente. En los primeros encendidos se aconseja mantener los locales bien aireados.

! Siempre que abra la puerta del hogar evite dejarla abierta durante mucho tiempo para evitar que el sensor de cierre informe del estado de puerta abierta, mediante una alarma sonora.

! El funcionamiento de la estufa está supeditado a una alimentación eléctrica correcta. En caso de falta de energía eléctrica, no encender la estufa!

3.2 ENCENDIDO

3.2.1 Encendido manual con leña

Operaciones a realizar:

1. utilizar la manija a disposición y empujar hacia arriba (Fig 3.2.);
2. colocar leña de pequeño tamaño en la base del hogar prestando especial atención de no obstruir el canal de carga del pellet;
3. ponga un encendedor de fuego natural encima del montón, añada unas ramas finas de madera cruzadas entre ellas y encienda desde arriba el encendedor;
4. cierre la puerta empujando la hoja hacia abajo hasta que se cierre por completo.

La estufa regula automáticamente la necesidad de aire comburente.

! PELIGRO

Para encender el fuego nunca use alcohol, gasolina, queroseno u otros combustibles líquidos.

Manténgalos alejados del fuego.

No use pastillas para encender el fuego derivadas del petróleo o de origen químico.

Use exclusivamente pastillas de tipo ecológico.

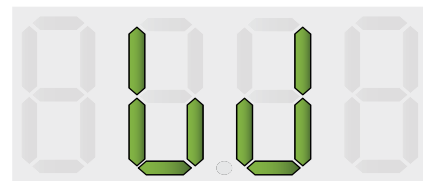

Fig. 3.1

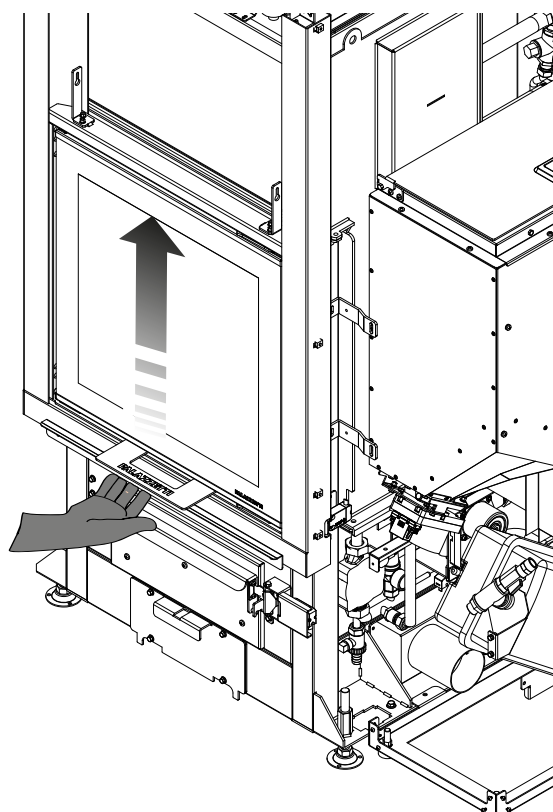



Fig. 3.2

La carga de la madera tendría que hacerse cuando la carga anterior se redujo a brasa.

No sobrecargue la estufa de leña; siga cargando la cantidad de combustible por hora indicada en las especificaciones.

Si durante el período de funcionamiento con leña (estado ) se ha habilitado un programa de encendido con pellets, la estufa no pasará automáticamente a pellets hasta que no se haya acabado de quemar la leña que hubiera en el hogar. Al finalizar la combustión de la leña se realiza un ciclo automático de limpieza del brasero, y si el programa aun está en la franja horaria activa, la estufa se encenderá con pellets.

3.2.2 Encendido automático con pellets

Asegúrese de que el depósito de pellets contenga una cantidad adecuada de pellets.

Para encender la estufa mantener presionado el botón  durante algunos segundos.

El icono en forma de llama comenzará a parpadear, durante la fase de encendido, hasta quedar fija con la estufa encendida.

! Encendido automático: La estufa está dotada de un dispositivo automático que permite el encendido del pellet sin recurrir al uso de otros encendedores tradicionales.

3.3 MODIFICACIÓN DE LOS PARÁMETROS DE FUNCIONAMIENTO

Es posible modificar los parámetros de funcionamiento de la estufa según lo indicado en el párrafo 1.3.



 Los valores programados serán mantenidos hasta la siguiente variación, incluso si la estufa está apagada o desconectada de la alimentación eléctrica.



3.4 CAMBIO DE COMBUSTIBLE

La estufa ofrece la posibilidad de poder cambiar el tipo de combustible (leña/pellet) mientras está funcionando.

3.4.1 Paso de leña a pellet

Si, durante el funcionamiento con leña se desea pasar al funcionamiento automático con pellets, basta con mantener pulsado el botón  durante algunos instantes:

1. el led de encendido  empezará a parpadear
2. al finalizar la combustión de la leña la estufa realizará una operación de limpieza
3. después de la limpieza la estufa se pondrá en funcionamiento con pellets y el led de encendido  permanecerá fijo.

 Si se ha configurado el paso a pellet, mantenga pulsada unos instantes la tecla  para desactivar dicha función (el led de encendido  no parpadeará más y aparecerá el mensaje "OFF").

3.4.2 Paso de pellet a leña

Si, durante el funcionamiento con pellets, se desea cambiar de combustible y pasar a la leña, bastará con:

1. abrir la puerta
2. cargar algunos troncos de leña en el brasero poniendo especial cuidado en no obstruir el canal de carga del pellet.
3. volver a cerrar la puerta

Si se ha realizado una carga suficiente de leña, después de algunos minutos la estufa se pondrá automáticamente en el funcionamiento con leña, y por lo tanto deberá recargarse manualmente más combustible si se desea mantener la combustión. Los símbolos [PELL]= aparecerán en la pantalla del menú de combustible cuando la estufa esté en posición pellet y [W]= cuando esté en posición de madera. En el menú del combustible del visualizador aparecerá el símbolo .

 Es necesario que durante la fase de carga de la leña la puerta permanezca abierta durante un lapso de tiempo superior a 3 segundos para dar a la estufa la posibilidad de conocer que se ha realizado la operación.

3.5 APAGADO

3.5.1 Apagado con leña

Para apagar la estufa cuando está en estado de funcionamiento con leña, basta con no cargar más combustible en el hogar. Al finalizar la combustión de la leña la estufa realizará un ciclo automático de limpieza del brasero.

3.5.2 Apagado con pellet

Para apagar la estufa cuando está en el estado de funcionamiento con pellets, mantener presionado el botón  durante algunos segundos; el icono con forma de llama se apagará.

Al finalizar la combustión, la estufa realizará un ciclo automático de limpieza del brasero.

 Se recomienda apagar la estufa siguiendo escrupulosamente lo anteriormente indicado y evitar absolutamente hacerlo desconectando la alimentación eléctrica.

3.6 FUNCIONAMIENTO CON TERMOSTATO AMBIENTE (SÓLO CON PELLETS)

Cuando la estufa es gestionada mediante un termostato (o cronotermostato) externo, el instalador debe haber programado la configuración 1.

En esta configuración la estufa se apaga cuando el termostato externo alcanza la temperatura programada (circuito abierto) o bien modula su funcionamiento (es decir la estufa intenta mantener la temperatura deseada consumiendo lo menos posible) al alcanzar la temperatura programada para el agua.

La estufa se reenciende automáticamente cuando la temperatura desciende por debajo del valor programado en el termostato externo (circuito cerrado).



En el primer encendido, o cuando el apagado se produce directamente desde la estufa (botón ) , se deberá proceder a encender la estufa directamente desde el panel de mando.



La estufa se apaga también si la temperatura del agua sigue aumentando a pesar de la modulación. En este caso la estufa se enciende solo si la diferencia entre la temperatura seleccionada y la temperatura real es mayor de 20°C.

Por eso, en esta configuración, nosotros aconsejamos de seleccionar un valor de temperatura del agua bastante alto (ej. 70°C).

3.7 FUNCIONAMIENTO CON Sonda AMBIENTE A BORDO CALDERA

La caldera puede encenderse/apagarse manualmente o en el modo programado.

En este tipo de configuración, la caldera modula la potencia en función de la temperatura ambiente leída por la sonda a bordo (es decir la caldera intenta mantener la temperatura deseada consumiendo lo menos posible).

Ante la posibilidad que el usuario haya habilitado la función “Eco-mode” en el submenú [7] del menú setup  , en lugar de modular, la caldera se apaga cuando alcanza la temperatura programada y se reenciende cuando la temperatura ambiente desciende por debajo del delta indicado en el submenú [8] del menú setup .



Es posible programar la temperatura deseada en el ambiente en el menú temperatura .

Mediante el submenú [6] del menú setup  es posible programar la temperatura deseada del agua de entrada (pedir al instalador termohidráulico que sugiera la temperatura más adecuada para el equipo de calentamiento).

3.8 FUNCIONAMIENTO EN COMBINACIÓN CON UN DEPÓSITO

Para el funcionamiento en combinación con un depósito, el instalador habrá programado la configuración de funcionamiento 3 o 4 según si se trata de depósito con o sin serpentina interna.

La caldera es comandada por la temperatura leída por la sonda del depósito.

Cuando se alcanza la temperatura programada del depósito, en el menú temperatura  la caldera se apaga y se reenciende si la temperatura desciende por debajo del delta indicado en el submenú [8] del menú setup .

En esta configuración se puede programar también la función anticongelación.

4 FUNCIONES DISPONIBLES

4.1 FUNCIÓN TEMPORIZADOR

Con esta función se pueden programar, habilitar y asignar a los diferentes días de la semana, los programas personalizados para el encendido y/o el apagado automático de la estufa.

Es posible programar hasta seis programas personalizados.

Para cada programa se pueden programar: hora de encendido, hora de apagado y temperatura deseada.

A cada día de la semana se le puede asignar hasta tres programas.

Los días de la semana se identifican por los números: Lunes = "d1", Martes = "d2";...; Domingo = "d7".

4.1.1 Configuración programas

- Usando los botones ir al menú setup y pulsar el botón ;
- Seleccionar la contraseña "7" con el botón y confirmar con el botón ;
- Seleccionar el submenú [2] y confirmar con el botón ;
- Pasar con los botones los programas P1...P6; seleccionar con el botón lo que se desea modificar;
- Parpadeará el valor de la hora de encendido, modificar el valor con los botones y presionar el botón ;
- Parpadeará el valor de los minutos, modificar el valor con los botones y presionar el botón ;
- Parpadeará el valor de la hora de apagado, modificar el valor con los botones y presionar el botón ;
- Parpadeará el valor de los minutos, modificar el valor con los botones y presionar el botón ;
- Parpadeará el valor de la temperatura deseada, modificar el valor con los botones y presionar el botón ;
- Presionar el botón para confirmar los datos programados.

4.1.2 Asignar los programas a los días

Con esta función se pueden asignar hasta tres programas diferentes a un solo día.

- Usando los botones ir al menú setup y pulsar el botón ;
- Seleccionar la contraseña "7" con el botón y confirmar con el botón ;
- Seleccionar el submenú [1] y confirmar con el botón ;
- Elegir con los botones el día [d1]...[d7] al cual se desean asociar los programas;
- Seleccionarlo con el botón ;
- Parpadeará el valor del primer programa a asignar: P1...P6 o bien "OFF" para deshabilitarlo;
- Modificar el valor con los botones y presionar el botón ;
- Parpadeará el valor del segundo programa a asignar: P1...P6 o bien "OFF" para deshabilitarlo;
- Modificar el valor con los botones y presionar el botón ;
- Parpadeará el valor del tercer programa a asignar: P1...P6 o bien "OFF" para deshabilitarlo;
- Modificar el valor con los botones y presionar el botón para confirmar los datos programados.

4.1.3 Habilitación/deshabilitación temporizador

- Usando los botones flecha ir al menú Temporizador ;
- Seleccionarlo con el botón ;
- Pasar con los botones y seleccionar: "ON" para habilitar el temporizador o bien "OFF" para deshabilitarlo;
- Presionar el botón para confirmar la selección.

Cuando el temporizador está habilitado aparece el icono fijo para indicar que el temporizador está activo.

4.2 FUNCIÓN AHORRO “ECO MODE”(SÓLO EN MODO PELLETT)

Habilitando esta función cuando la estufa alcanza la temperatura deseada en el ambiente, se apaga. Si dicha función no es habilitada, la estufa modula su funcionamiento para mantener la temperatura deseada consumiendo lo menos posible. La función “Eco Mode” está disponible sólo en la configuración 2.

Para habilitar/deshabilitar dicha función:

- Usando los botones ir al menú setup y pulsar el botón ;
- Seleccionar la contraseña “7” con el botón y confirmar con el botón ;
- Seleccionar el submenú [7] y confirmar con el botón .
- Programar con los botones no de los siguientes valores:
 - Eco → Activa la función “Eco Mode”
 - Off → Disactiva la función “Eco Mode”
- Presionar el botón para confirmar los datos programados.

4.3 FUNCIÓN DELTA DE REENCENDIDO

Delta de reencendido (en las configuraciones de instalación 2, 3 y 4): es el número de grados centígrados por debajo de la temperatura de apagado superado el cual la estufa se reenciende automáticamente. Por ejemplo, si la estufa se programa para que se apague a 20°C (Modo Eco activo) y se programa un “Delta de reencendido” de 4°C, la estufa se reencenderá cuando registre una temperatura inferior o igual a 16°C.

Configuración 2:

Para modificar el valor del delta de reencendido:

- Usando los botones ir al menú setup y pulsar el botón .
- Seleccionar la contraseña “7” con el botón y confirmar con el botón .
- Seleccionar el submenú [8] y confirmar con el botón .
- Papadeará el valor; modificarlo con los botones y (0,5 ... 5,0°C);
- Presionar el botón para confirmar el dato programado.

Configuración 3 e 4:

Para modificar el valor del delta de reencendido:

- Usando los botones ir al menú setup y pulsar el botón .
- Seleccionar la contraseña “7” con el botón y confirmar con el botón .
- Seleccionar el submenú [8] y confirmar con el botón .
- Papadeará el valor; modificarlo con los botones y (0 ... 40°C);
- Presionar el botón para confirmar el dato programado.

4.4 FUNCIÓN AUTONOMÍA

Con esta función se pueden visualizar las horas de autonomía restantes antes de realizar la carga de pellets.

Desplazando con las teclas flecha en el símbolo el visor mostrará las horas de autonomía estimadas antes de tener que cargar con pellets. La autonomía se calcula en función de los parámetros de trabajo configurados en ese momento en la estufa.

Los valores estimados son suficientemente esperables a condición de que en cada nuevo suministro completo de pellets se seleccione y confirme el valor “FULL”. El valor “Lo” indica el estado de reserva.

4.5 FUNCIÓN RECARGA

Con esta función se puede comunicar a la estufa si se está cargando con pellets el depósito.

De este modo, en función de los parámetros de funcionamiento, la estufa es capaz de estimar cuantas horas de autonomía le quedan antes de tener que cargar con pellets el depósito.

Después de llenar completamente el depósito de pellet:

- Desplazarse con los botones flecha al icono del combustible y presionar enviar .
 - Seleccionar con los botones la sigla “FULL” y presionar enviar .
- Si se desea deshabilitar dicha función, seleccionar “OFF” en lugar de “FULL”.









4.6 REENCENDIDO DESPUÉS DEL BLACK-OUT

En caso de interrupción momentánea de corriente eléctrica, la estufa se volverá a encender automáticamente, comprobando las condiciones de seguridad al volver la alimentación.

4.7 FUNCIÓN “BLOQUEO BOTONERA”

Con esta función es posible bloquear el uso del panel de mando para evitar modificaciones accidentales.

Para habilitar/deshabilitar dicha función:









- Usando los botones ◀ ▶ ir al menú setup  y pulsar el botón .
- Seleccionar la contraseña “7” con el botón  y confirmar con el botón .
- Seleccionar el submenú [1 0] y confirmar con el botón .
- Programar con los botones   uno de los siguientes valores:
 - “Off” Bloqueo botonera desactivado
 - “Lo” Queda habilitado sólo el botón de encendido/apagado 
 - “Hi” Bloqueo botonera activado
- Presionar el botón  para confirmar los datos programados.

4.8 FUNCIÓN ANTICONGELACIÓN

En las configuraciones de instalación 2, 3 y 4 es posible programar una temperatura mínima por debajo de la cual la caldera se enciende (fuera de las franjas horarias programadas).









Configuración 2:

Para modificar el valor de la temperatura “anticongelación”:

- Usando los botones ◀ ▶ ir al menú setup  y pulsar el botón .
- Seleccionar la contraseña “7” con el botón  y confirmar con el botón .
- Seleccionar el submenú [9] y confirmar con el botón .
- Parpadeará el valor, modificarlo con los botones   (OFF; 3...20°C);
- Presionar el botón  para confirmar el dato programado.

Configuración 3 e 4:







Para modificar el valor de la temperatura “anticongelación”:

- Usando los botones ◀ ▶ ir al menú setup  y pulsar el botón .
- Seleccionar la contraseña “7” con el botón  y confirmar con el botón .
- Seleccionar el submenú [9] y confirmar con el botón .
- Parpadeará el valor, modificarlo con los botones   (OFF; 3...50°C);
- Presionar el botón  para confirmar el dato programado.

Si en el punto d se programa el valor “OFF”, esta función es deshabilitada.

4.9 ACTIVACIÓN MANUAL DEL SISTEMA DE CARGA DE PELLET

En el momento del primer encendido, o si el depósito está totalmente vacío, una vez cargado el pellet en el depósito, es posible activar manualmente el sistema de carga para que el pellet llene el circuito correctamente:

- Mediante las teclas flecha ◀ ▶ ir al menú Setup  y pulsar la tecla .
- Seleccionar la contraseña “7” con la tecla  y confirmar con la tecla .
- Seleccionar el submenú [3 1] y confirmar con la tecla .
- Seleccionar la contraseña “54”
- Mantener pulsada la tecla  para activar el sistema de carga manual.



Es posible activar el procedimiento sólo con la estufa apagada y totalmente fría.

4.10 ACTIVACIÓN MANUAL DEL SISTEMA MECÁNICO DE LIMPIEZA DEL BRASERO

En caso de presentarse la necesidad de activar manualmente el sistema mecánico de limpieza del brasero:

- a) Mediante las teclas flecha ◀ ▶ ir al menú Setup ⚙️ y pulsar la tecla ⏪;
- b) Seleccionar la contraseña "7" con la tecla + y confirmar con la tecla ⏪;
- c) Seleccionar el submenú [32] y confirmar con la tecla ⏪;
- d) Seleccionar la contraseña "54" y confirmar con la tecla ⏪;
- e) Mantener pulsada la tecla ⏪ para activar el sistema de carga manual.





Es posible ejecutar el procedimiento sólo con la estufa apagada y totalmente fría.

5 GESTIÓN DE LAS ALARMAS

5.1 DESCRIPCIÓN DE LOS MENSAJES

Si se produce una anomalía en el funcionamiento, se activa el siguiente procedimiento:

- 1) Alarma acústica (beep);
- 2) Se ilumina uno de los siguientes led de sistema:   ;
- 3) Si la anomalía se refiere a un error, la estufa se apagará (si está funcionando por pellet).

La presión prolongada del botón “anular”  permite la visualización en el visor del código de error:

CÓDIGO ERROR/AVISO	DESCRIPCIÓN	POSIBLES CAUSAS	LED
E001	Panel de mando defectuoso	Defecto del panel de mando	
E002	Error de comunicación señal de mando a distancia	Defecto del panel de mando	
E004	Error de comunicación	Cable de conexión entre la tarjeta y el panel de mando interrumpido o desconectado. Si aparece durante el cambio de configuración, ignorar dicho error.	
E101	Error de no encendido Agua de entrada muy caliente	Faltan pellets Calidad del pellet Sistema de encendido averiado Brasero sucio Problemas en la instalación de calefacción Problemas en el circulador	
E104	Sistema de limpieza del brasero bloqueado	Un cuerpo extraño impide el funcionamiento correcto del sistema de limpieza de la base del brasero.	  
E105	Malfuncionamiento sonda de temperatura	Sonda agua de retorno defectuosa	
E106	Malfuncionamiento sonda de temperatura	Sonda de ambiente/puffer defectuosa	
E107	Mal funcionamiento sonda de la cámara de combustión	Sonda cámara de combustión defectuosa	
E108	Error dispositivo de seguridad térmica	Problemas en la instalación de calefacción Problemas en el circulador Problemas de sobrecalentamiento del depósito pellet	
E109	Error de presión o en el control del aire	Sistema de expulsión de humos sucio Juntas estancas desgastadas Aire de combustión insuficiente Problemas en el sistema de control del aire de combustión	
E110	Malfuncionamiento sonda de temperatura	Sonda agua de entrada defectuosa	
E111	Mal funcionamiento sonda humos	Sonda temperatura humos defectuosa	
A002	Aviso de mantenimiento programado (<i>icone lampeggianti</i>)	Periódicamente la estufa indica que se debe realizar un mantenimiento por parte de un técnico especializado	  
A006	Aviso puerta o cajón abiertos	Puerta del hogar o cajón de cenizas abiertos	  
A007	Mal funcionamiento sensor de presión. (<i>iconos intermitentes</i>)	Sensor de presión o tarjeta averías	
----	Limpieza estufa	Cámara de combustión, brasero o sistema de evacuación de humos. Tubos registro de presión separados u obstruidos. Entrada del aire comburente obstruida.	
----	Error de no encendido	Pellet agotados, Resistencia de encendido averiada, Guarniciones gastadas, Puerta del hogar abierta.	

5.2 RESET DE LAS ALARMAS

Después de comprobar el tipo de mensaje es posible reajustar la alarma presionando algunos instantes el botón de encendido/apagado (⏻).

5.2.1 Casos particulares (a cargo del Centro de Asistencia Técnica):

Error "E108"

Si el código de error es "E108", puede ser necesario reactivar los termostatos de restablecimiento manual (Fig. 5.1) desenroscando los tapones de protección y pulsando las teclas de restablecimiento.

Resetear la alarma pulsando unos instantes la tecla de encendido/apagado (⏻).

Ahora es posible proceder a un nuevo encendido.

Error "E104"

Si el código de error es "E104":

- Quitar todos los cuerpos extraños del brasero.
- Si están bloqueados, es necesaria la activación manual del sistema mecánico de limpieza del brasero:

- a) Mediante las teclas flecha (◀ ▶) ir al menú Setup ⚙️ y pulsar la tecla (↔);
- b) Seleccionar la contraseña "7" con la tecla (+) y confirmar con la tecla (↔);
- c) Seleccionar el submenú [32] y confirmar con la tecla (↔);
- d) Seleccionar la contraseña "54" y confirmar con la tecla (↔);
- e) Mantenga pulsada unos segundos la tecla (↔) para activar un ciclo de limpieza del brasero.

- Durante la limpieza, pulsar cinco segundos el microinterruptor (Fig. 5.2) manteniendo cerrada la puerta del hogar.
- Reabrir la puerta del hogar y comprobar que el brasero haya quedado libre de cuerpos extraños.
- Resetear la alarma pulsando unos instantes la tecla de encendido/apagado (⏻).
- Esperar unos minutos y proceder a un nuevo encendido.



Es posible ejecutar el procedimiento sólo con la estufa apagada y totalmente fría.

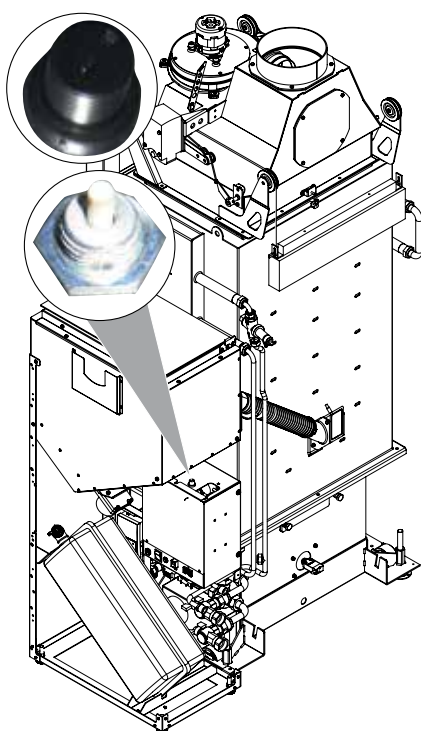

Fig. 5.1

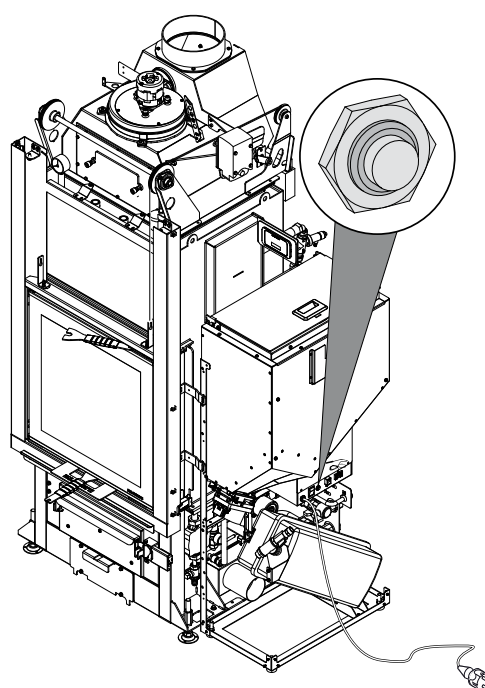

Fig. 5.2

PALAZZETTI

IL CALORE CHE PIACE ALLA NATURA

Palazzetti Lelio s.p.a.
Via Roveredo, 103
cap 33080 - Porcia (PN) - ITALY
Internet: www.palazzetti.it

Per conoscere il centro di assistenza tecnica
(CAT) più vicino a te consulta il sito

www.palazzetti.it

oppure chiama il numero



La Ditta Palazzetti non si assume alcuna responsabilità per eventuali errori del presente opuscolo e si ritiene libera di variare senza preavviso le caratteristiche dei propri prodotti.

Palazzetti accepts no liability for any mistakes in this handbook and is free to modify the features of its products without prior notice.

Die Firma Palazzetti übernimmt für eventuelle Fehler in diesem Heft keine Verantwortung und behält sich das Recht vor, die Eigenschaften ihrer Produkte ohne Vorbescheid zu ändern.

Palazzetti décline toute responsabilité en cas d'erreurs dans la présente documentation et conserve la faculté de modifier sans préavis les caractéristiques de l'appareil.

La empresa Palazzetti no se responsabiliza de los errores eventuales de este manual y tiene el derecho de modificar sin previo aviso las características de sus productos.